

Application Note

AN9027



FNICO Non-Incendive Fieldbus System



Contents

	Page
1 INTRODUCTION	1
1.1 About this document	1
1.2 Background	1
1.3 Principle	1
1.4 Cables	2
1.5 Power supplies	2
1.6 Field devices	2
1.7 Documentation and inspection	3
1.8 Conclusion	3
2 POWER SUPPLIES	3
2.1 Introduction	3
2.2 Non-incendive output	3
2.3 Host port	4
2.4 24V supply	4
2.5 Screen terminals	4
2.6 Status indicators	4
3 CONNECTING FIELD DEVICES TO A FNICO POWER SUPPLY	5
3.1 Introduction	5
3.2 Output voltage and current	5
3.3 Cable resistance	5
3.4 Field device, voltage and current	5
3.5 Typical calculation for IIC (9111-NI) power supply	6
3.6 Typical calculation for a IIB (9112-NI) power supply	7
4 COMMISSIONING AND FAULT FINDING IN A FNICO SYSTEM	8
4.1 Introduction	8
4.2 Facilities	8
4.3 Specialist test equipment	9
4.4 Procedure	9
5 FNICO INSTALLATION REQUIREMENTS	10
5.1 General	10
5.2 Cables	11
6 ESTABLISHING SAFETY COMPATIBILITY BETWEEN FIELD DEVICES AND FNICO POWER SUPPLIES ..	12
6.1 Intrinsically safe field devices	12
6.2 Non-incendive field devices	13
6.3 EEx nL devices	13
6.4 Terminators and connecting blocks	13
6.5 Marking of IS devices used in a FNICO system	13
6.6 Re-use of intrinsically safe field devices	13
7 EARTHING	14
7.1 Introduction	14
7.2 Trunks	14
7.3 Screens/shields	14
7.4 Other earths	14

8	CABLES AND ACCESSORIES	14
8.1	Cables	14
8.2	Terminators	15
8.3	Wiring hubs and enclosures	15
9	SURGE PROTECTION	16
9.1	Introduction	16
9.2	Compatible surge protection devices	17
9.3	Protecting the system	18
10	MOUNTING OF FNICO POWER SUPPLIES IN ZONE 2 AND DIVISION 2	19
10.1	General	19
10.2	Typical installation	19
10.3	Environmental considerations	20
10.4	Maintenance and fault finding	20
10.5	Further combinations	20
11	CERTIFICATION AND SAFETY DOCUMENTATION OF FNICO SYSTEMS	21
11.1	Introduction	21
11.2	MTL FNICO power supplies	21
11.3	MTL terminator	21
11.4	MTL 24V Zone 2/Division 2 power supply	21
11.5	Cables	21
11.6	Interconnection blocks	21
11.7	Enclosures and glands	22
11.8	Simple apparatus	22
11.9	Safety documentation	22
11.10	Documenting the safety of a FNICO installation	22
11.11	Safety documentation for a FNICO system	23
12	APPENDIX I : SIMPLE APPARATUS AND THE ATEX DIRECTIVE	24
12.1	Introduction	24
12.2	Standards	24
12.3	Conclusion	24
13	APPENDIX II : EXTRACT FROM BS EN 50020: 2002	25
14	APPENDIX III : FNICO TECHNICAL SPECIFICATION	26
15	APPENDIX IV : FACTORY MUTUAL INSTALLATION DRAWING.	30

1 INTRODUCTION

1.1 About this document

This application note is a practical guide to the selection, installation and maintenance of equipment complying with the Fieldbus Non-Incendive COncept (FNICO) for fieldbus systems in Zone 2 and Division 2 hazardous areas. The document begins with a discussion of the origins of FNICO and follows with a review of the main elements to be considered when assembling FNICO systems. Further sections develop each subject in more detail. The intention is to provide clear guidance to new and experienced fieldbus users.

The document will be updated regularly to reflect changes in practice and to incorporate new information as it emerges. Please make sure you have the most recent version by visiting the MTL website www.mtl-inst.com or contacting your local MTL representative. (The issue number of this application note is shown on the top right-hand corner of the Contents page.)

FISCO (Fieldbus Intrinsically Safe COncept) systems are separately discussed in companion MTL application note AN9026. There are some advantages in reading the two documents at the same time, as they interact in a number of places.

The commonly used term 'H1' is used in the text to describe the low frequency fieldbus (31.25kbits/s) as defined by FOUNDATION™ Fieldbus.

IEC terminology is used throughout the document when referring to Gas and Apparatus Groups. North American equivalents are as follows:

IEC	North America
IIC (Hydrogen)	Groups A, B
IIB (Ethylene)	Group C

Table 1 - Gas group comparison

The document elects to use the term 'non-incendive'. It is synonymous with the IEC term 'energy-limited' in this context and is the low power technique described in the North American non-incendive standards FM3611 and ANSI/ISA-12.12.01-2000.

1.2 Background

The non-incendive approach to achieving safety in Zone 2 or Division 2 hazardous areas is essentially the same as the intrinsically safe concept except that the apparatus need not be fault tolerant. Because of the need to permit live maintenance, open circuits and short circuits of the field wiring are considered as normal operation, in the same way as for intrinsically safe circuits.

The principles of the recently-introduced FISCO Technical Specification (IEC/TS 60079-27) can be applied to the non-incendive concept, while exploiting the additional benefits that derive from the relaxed regulations applicable in Zone 2 and Division 2. The key benefits of FISCO that automatically transfer into FNICO are as follows:

- Simple safety assessment. The safety documentation is reduced to a list of devices, and new devices can be added without re-evaluating the safety case.
- Elimination of cable parameter calculations, provided the cable complies with a minimum requirement for resistance, capacitance and inductance per unit length.

FNICO also has the following additional benefits when compared with FISCO:

- Higher levels of available current for the field wiring, permitting more field devices to be connected onto the hazardous area trunk.

- Relaxed rules for establishing safety compatibility between field devices and the fieldbus power supply.

The MTL version of the FNICO Technical Specification is given in Appendix III. At the present time (June 2003) the draft specification is being reviewed by the national certifying authorities and is a subject of discussion within the IEC Intrinsic Safety committee. MTL is pursuing its ultimate adoption as an IEC standard. If and when such a standard does emerge, it may differ in detail from the MTL document but the constraints are so well defined it is not likely that there will be significant differences in principle.

One significant difference between IEC and North American practice is that North America only permits 90% of the current derived from the relevant curves to be used, and the IEC standard permits 100%. In calculating the permitted current in the MTL standard the factor of safety of 0.9 has been used since this errs on the side of safety and increases the international acceptability of the proposal.

The inductance and capacitance values, and the cable lengths and parameters used in the FNICO technical specification are the same as those used in the FISCO document. This is because the safety factor has been reduced and consequently the stored energy level has already been increased to the maximum acceptable level. It can however be argued that the permitted effective input capacitance (Ci) and input inductance (Li) of field devices may be increased. In particular since the input inductance only carries the operating current of the individual device then higher values of residual inductance are permissible. This exception is described in Section 6.1.3.

Another major advantage of the non-incendive approach is that temperature classification is determined in normal operation. When considering non-incendive field devices the temperature classification is determined by the power consumption of the device, and is independent of the power available from the supply. Similarly the relevant current is the current drawn by the device not the available supply current.

The code of practice for installation in hazardous areas (IEC 60079-14) and the Zone 2 apparatus standard (IEC 60079-15) do not give very positive guidance on the earthing and bonding of non-incendive systems. The MTL standard follows the same practice as the FISCO standard since that presents no significant practical problems, reduces the differences between the systems, and is adequately safe. The standard permits 'earthing' of the power supply as the single point at which the non-incendive trunk is bonded. The MTL FNICO power supply produces a floating non-incendive trunk, which has the merit of being less susceptible to earth faults, and its balanced operation increases its immunity to certain types of interference. The individual isolation of the 24V supply, the host trunk, and the non-incendive trunk provides for the maximum flexibility in earthing practice and immunity from earth faults. This feature is desirable, but not essential for safety reasons and consequently does not form part of the standard.

Many users of instrumentation in Zone 2 and Division 2 locations have established practices that have proved to be practical and adequately safe, and if it is preferred, then these should be adapted to embrace fieldbus installations. *This application note is an MTL opinion, which proposes an approach that is practical and adequately safe. It is not suggested that it is the only adequate approach, but in the absence of other guidance provides a basis for creating a practical and safe installation.*

1.3 Principle

The German approvals organisation PTB, in collaboration with German industry, examined the intrinsically safe needs of the 31.25kbit/s physical layer of fieldbus and developed an approach that is applicable to both Profibus-PA and FOUNDATION™ Fieldbus H1 systems. PTB report W-53e dated August 1994 provides details of the experimental evidence and the initial thinking on which the Technical Specification IEC/TS 60079-27 is based. From this proposal, the IEC specification emerged with only very minor modifications. The result is a comprehensive document, which covers all aspects of a low frequency fieldbus system that allows a system to be

built with only a minimum analysis of the safety requirements and very simple documentation. The design of the apparatus is made slightly more difficult so that the system configuration is made easier. Arguably this tends to improve safety since the apparatus is certified and the manufacturer is subjected to surveillance, whereas system design and installation is less tightly controlled.

The FNICO Technical Specification is largely derived from the FISCO work, taking into account the relaxations that may be applied in Zone 2 and Division 2. FNICO follows the FISCO model by permitting the associated apparatus to be designed for connection into IIB as well as IIC gas groups, thereby increasing the available current when the area classification permits.

1.4 Cables

One of the more interesting results of the FISCO experimental work was that adding standard instrument cable to a power supply reduces the incendivity of the system rather than increasing it. Previously it was assumed that the cable inductive and/or capacitive stored energy was available to supplement the energy available from the source of power. The experimental evidence however suggests that the cable parameters, because of their distributed nature, modify the form of the test apparatus spark so as to make it less incendive. There is also some theoretical analysis to support this view.

However because the experimental work covered only a limited range of cable parameters, circuit voltage and current, it was considered prudent to limit the acceptable cable parameters in a FISCO circuit. The same values have been adopted for FNICO, as given in Table 2.

Parameter	Value
Loop resistance R_C	15Ω/km to 150Ω/km
Loop inductance L_C	0.4mH/km to 1mH/km
Capacitance C_C	80nF/km to 200nF/km
Max. length of each spur cable	30m in IIC and IIB
Max. length of each trunk cable	1km in IIC and 5km in IIB

Table 2 - FNICO cable parameters

These limits are not restrictive, since a typical fieldbus trunk cable has parameters of 50Ω/km, 0.8mH/km and 120nF/km. The length of the trunk is usually determined by the operational requirements.

The non-incendive field wiring of FNICO systems must be installed in accordance with the prevailing wiring regulations in the country of installation. Non-incendive circuits must not share the same multi-core cable as intrinsically safe circuits.

1.5 Power supplies

The non-incendive output of FNICO power supplies must be assessed against the published ignition curves using the 0.9 factor of safety on current, while taking into account the maximum voltage and current limits specified in the FNICO technical specification. Electronic current limitation is permissible, although the response to short circuits must be rapid in order to prevent ignition-capable current spikes from passing through to the output.

In practice, the available output power is less than that of the safety parameters because the tolerances of all components, which affect the output voltage and current, must be taken into account. In other words, the safety parameters are calculated when all tolerances conspire in the least favourable direction.

The calculation of how many field devices can be powered from a power supply is a relatively simple application of Ohm's Law taking into account the current consumption of each field device, the voltage drop in the trunk cable, and that the field devices require 9V to operate. If the assumption is made that the field devices require 20mA

and are all at the remote end of the non-incendive (NI) trunk, then the number of devices which can be powered from the MTL FNICO IIC power supply is nine at the end of a 600m trunk. The corresponding IIB power supply will supply sixteen devices at the end of a 300m trunk, demonstrating the desirability of a IIB gas classification where that is acceptable. The number of devices connected to a bus is also determined by the plant layout, and by consideration of the system reliability. If the available trunk length is a limitation, moving the repeater power supply into the field, (which may be a Zone 2 or Division 2) may provide a solution.

A typical FNICO power supply is illustrated and pictured in Figure 1. This power supply incorporates isolation from its source of power and the host bus, the necessary terminator, and some diagnostic capability. These are not FNICO requirements but are operationally desirable.

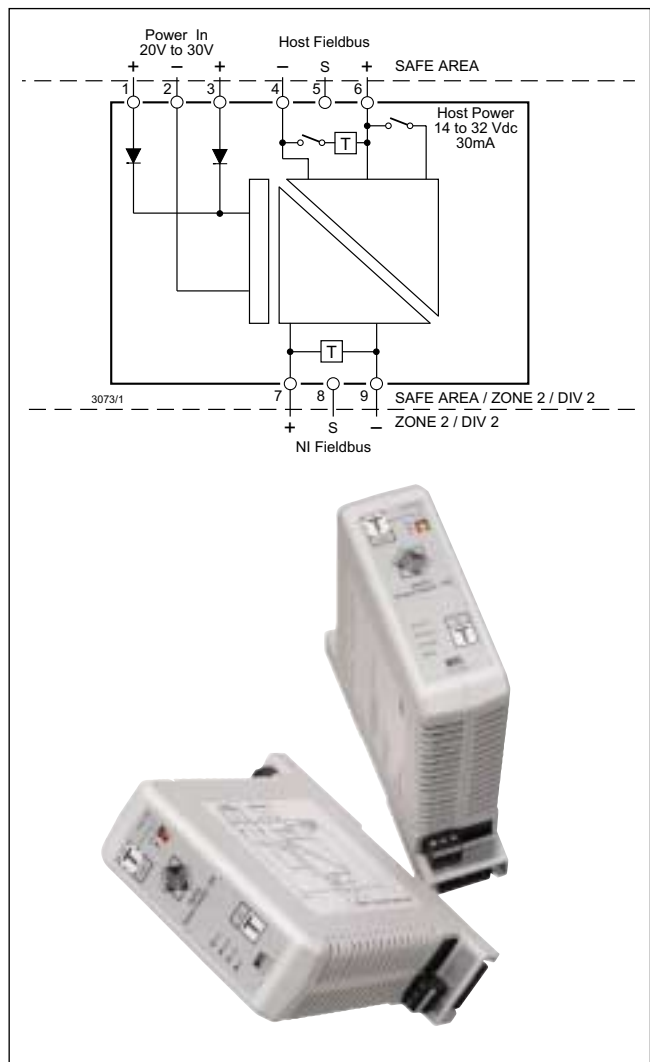

Figure 1 - FNICO power supply

Refer to Section 2 for a more detailed discussion of power supplies for FNICO.

1.6 Field devices

The specification of the fieldbus field devices is determined by the requirement to be compatible with the FNICO power supply, and also that additional devices can be added to a system without having to reconsider the system safety.

For installations in IEC Zone 2 hazardous areas, field devices may have either of the following approvals:

- Intrinsically safe
- Type of protection 'n', with Ex nL (energy-limited) circuits

For installations in North American Class I, Division 2 hazardous locations, field devices may have either of the following approvals:

- Intrinsically safe
- Non-incendive with 'non-incendive field wiring parameters'.

Field devices complying with the FISCO technical specification and having input parameter of voltage (Ui) 17.5V, current (Ii) 380mA, capacitance (Ci) 5nF and inductance (Li) 10µH may be used in a FNICO system. For such devices, safety is easily established. However, the requirement for safety to be maintained only in normal operation means that it is not necessary to match the output current of a FNICO power supply with that of the receiving device, meaning that the Ii and I0 figures do not need to be compatible. In addition, a relaxation of the Li figure from 10µH to 20µH is also justified, which permits the use of 'Entity' certified IS devices. These relaxations are discussed in further detail in Section 6. Field devices may have any temperature classification, but the majority are likely to be T4 (135°C).

The requirements for field devices in a FNICO system may therefore be summarised as $U_i \leq 17.5V$, $C_i \leq 5nF$ and $L_i \leq 20\mu H$. In practice, fieldbus devices certified intrinsically safe to FISCO or the FF-816 physical layer specification are acceptable.

1.7 Documentation and inspection

A major benefit of the FNICO system is that no detailed analysis is necessary to ensure the safety of the system, and additions do not require a reevaluation of the whole system. The gas group of the system is determined by the power supply, and the temperature classification of each piece of apparatus by its certification (usually T4).

The documentation is only a list of the connected apparatus. This is normally done electronically and can readily cross-refer to the certification documents of the apparatus.

A further advantage of this system is that the inspection procedure is simplified to ensuring that the system is unchanged and undamaged. Many of the field devices may carry a unique identifier and part of the inspection procedure can be done automatically as part of the 'asset management' program. An occasional inspection for mechanical damage is still necessary, but if the equipment is unchanged and operational it is unlikely to be unsafe.

Documentation requirements of FNICO systems are described in more detail in Section 11.

1.8 Conclusion

FNICO transfers the benefits of FISCO into hazardous areas that are classified as Zone 2 or Division 2. The reduced factor of safety that may be applied in these areas permits higher levels of current to be transferred to the field wiring, allowing more field devices to be connected to the hazardous area trunk. The ability to connect and disconnect field devices while under power in the hazardous area is preserved, in the same way as with intrinsic safety. This facility avoids the necessity for 'gas clearance' procedures.

The relaxation in the design requirements of the apparatus is useful but it is likely that the same field devices will be used for both FISCO and FNICO installations and hence this advantage is restricted. A significant advantage for European installations is that Category 3 equipment to the ATEX directive, which is usually type 'n' apparatus for use in Zone 2 locations, can be 'self-certified' by the manufacturer.

FNICO may therefore be considered as an alternative and more flexible approach to FISCO in flammable atmospheres where the hazard is not expected to occur in normal operation.

2 POWER SUPPLIES

2.1 Introduction

MTL's 911x-NI Series power supplies are designed to meet the

requirements of FNICO technical specification, and to fully exploit the benefits of the technique. They will provide power and the signal repeater function for a non-incendive fieldbus trunk that is installed in a Zone 2 or Division 2 hazardous area.

The basic functions of the power supply are illustrated by Figure 2, which also shows a common but simple application. The power supply is shown mounted in a safe area. It may be mounted in a Zone 2 or Division 2 location, as discussed in Section 10 of this application note.

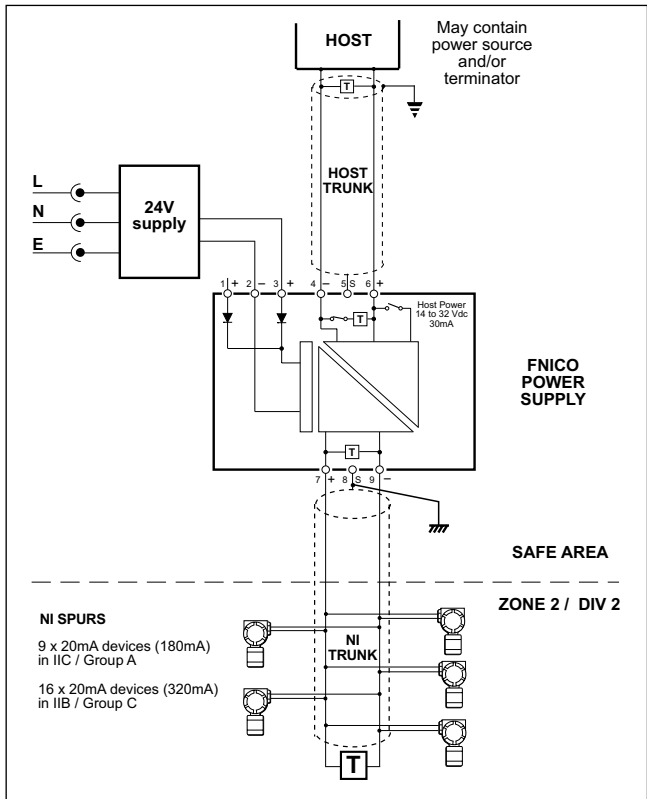

Figure 2 - Block diagram of simple FNICO system

The FNICO power supply converts a 24V input into a non-incendive power supply which feeds the 'NI' trunk. The fieldbus signal, which is superimposed on this voltage, is fed into a repeater for transmission to and from the system host.

There are currently two MTL FNICO power supplies: the 9111-NI is suitable for use where a IIC (hydrogen) apparatus classification is required, and the 9112-NI, where a IIB (ethylene) classification is adequate. They differ only in output characteristics, the IIB version having more output power.

2.2 Non-incendive output

The permitted safety parameters (U_0 , I_0) of FNICO power supplies are defined in the FNICO technical specification. The available power is always less than that permitted by the safety parameters.

The safety parameters and useable output of the MTL FNICO power supplies are listed in Table 3.

Model number	Apparatus Class	Safety Parameters		Useable Output	
		U_0 V	I_0 mA	V	mA
9111-NI	IIC	14	233	12	180
9112-NI	IIB	14.8	380	12.8	320

Table 3 - FNICO power supply output characteristics

The choice of output voltage is made so as to maximise the number

of field devices that can be connected to each power supply. The FNICO power supplies have a single level of voltage and current limiting; unlike intrinsically safe circuits, duplication or triplication of components upon which safety depends is not necessary.

The bi-directional fieldbus signal has to be developed across the power supply and be transferred to the host port, which repeats the signal to the host. This means that the power supply must have low impedance at low frequencies to give a constant voltage as a source of power, and high impedance at the signal frequency of 31.25kbits/sec. This shaped impedance characteristic is achieved by using an active filter, which must operate without adversely affecting the non-incendive characteristics of the power supply.

The useable output current quoted allows for the inrush current associated with the initial connection of a field device, and hence no further allowance for this is necessary.

The NI trunk must be correctly terminated at each end and a permanently connected terminator for this purpose is included in the power supply.

The NI output is separated from the source of power and the repeated fieldbus signal so as to withstand 250V isolation. This three port isolation simplifies the design of the system since it removes the possibility of interaction between the circuits. A further advantage is that it removes the possibility of interaction between earth faults on the different circuits, which are frequently the cause of operational faults. This type of fault is extremely difficult to diagnose. Normally the NI fieldbus circuit is operated in a fully floating mode, without any direct connection to earth. A single earth fault unbalances the circuit and introduces some noise. In most cases the circuit continues to operate, but it becomes noisy and less reliable. However the circuit may fail completely. Multiple earth faults on the same circuit invariably lead to operational failure.

It is usual that a non-incendive circuit is fully floating or earthed/grounded at one point, and some codes suggest that isolation should be periodically checked. The non-incendive fieldbus circuit is self-checking in respect of multiple earths and hence an isolation check on a functional system is not necessary.

2.3 Host port

The connection for the repeater trunk, which is usually the connection for the host trunk, is a normal fieldbus port. The port requires 9V and a small quiescent current (less than 4mA) to operate. The bi-directional signal transmitted through the repeater is reshaped, thus improving the quality of the transmitted signal. Since the galvanic isolation from the non-incendive supply is designed to remain safe when connected to a source with the fault capability of a 250V mains supply ($U_m:250V$), there is no requirement for the host or host trunk to conform to any special requirements. Any conventional arrangement is acceptable, and this avoids the special consideration necessary when lower values of U_m are used.

A major advantage of the three-port isolation of the MTL 9111-NI and 9112-NI power supplies is that both the host trunk and the 24V supply can be operated with small common mode voltages or referenced to different earths without any significant interaction between the ports. Normally these connections are earthed or left 'floating', and any common-mode voltages are small (less than 36V). Although the design of the power supplies permits common mode voltages as high as 250V, their use with high voltages in normal operation introduces a number of practical problems and should be avoided. On those rare occasions where it is unavoidable, then special consideration needs to be given to personnel safety, for example additional marking would be necessary. The presence of high common mode voltages where the power supplies are mounted in Zone 2 or Division 2 requires very special consideration and, although possible, is not recommended.

The MTL 9111-NI and 9112-NI units contain a power supply that can be used to power the host trunk. When the host trunk is powered from the host, the supply in the MTL unit is switched out. This power supply can provide up to 30mA within the permissible voltage range of 14

to 32V, and provides sufficient power to meet the requirements of most existing hosts which do not have a power supply. It is important that a trunk has only one source of power, unless specific attention has been given to ensure that an impedance mismatch or undesirable circulating currents cannot occur. The normal practice is therefore to use a single source of supply, either the host or the power supply in the MTL FNICO module.

In addition the unit contains a terminator which can be switched in to terminate one end of the host trunk. There should only be one terminator at the end of each trunk. Hence where additional field devices or multi-dropped FNICO power supplies use the host trunk, only the MTL FNICO module at the end of the trunk should have its terminator switched in.

The configuration already illustrated in Figure 2 is the usual pattern. However the host trunk can be used to interconnect other devices, including other MTL power supplies. The limitations are usually the amount of data that the host can accommodate, the current available from the host trunk power supply, and the resistance of the host trunk. In practice the small current required by the host port allows the host trunk to be very long (1.8km) unless field devices which require very high standing currents also use this trunk. This attribute is useful if the power supply is used as a repeater to extend the effective trunk length.

2.4 24V supply

Since the non-incendive output is also galvanically isolated from the 24V connections with the capability to remain safe with a 250V mains fault, then the unit providing the 24V feed to the FNICO power supplies can be any type of conventional construction.

The IIC FNICO power supply (9111-NI) requires a maximum of 280mA at 24V and the fully loaded IIB supply (9112-NI) requires 460mA at 24V. The FNICO power supplies have steering diodes associated with the 24V terminals so that if duplicate 24V supplies are used then a common mode failure due to one supply failing does not occur. The diodes also serve to prevent damage to the FNICO power supply if the polarity of the 24V supply is accidentally reversed.

There are two MTL 24V power supplies suitable for this application. The MTL 5991 operates over the voltage range 85 to 264Vac and supplies a minimum of 1.7A (output current 2A when the supply voltage is greater than 105V). This is more than adequate for the majority of safe area applications. Where a higher power is required or the power supply is to be located in a Zone 2 or Division 2, then the MTL power supply type 8914-PS-AC should be used. This works over the same voltage range, provides up to 10A, and is approved for Division 2 use by FM and certified as Category 3 apparatus in Zone 2 in accordance with the ATEX Directive. For more information on these power supplies see their individual data sheets available at www.mtl-inst.com.

2.5 Screen terminals

Terminals are provided for anchoring the screens/shields of both the trunk cables. These terminals are not electrically connected to anything inside the module, and only provide mechanical support. The recommended practice is to secure a braided screen in a ferrule and secure it in the terminal. The drain wire of a wrapped screen is normally secured by the terminal, and the end of the cable sleeved to tidy up the exposed wrapping.

The screens/shields should be earthed/grounded at one end. Usually the NI trunk screen should be earthed at the FNICO power supply and the host trunk screen earthed at the host.

2.6 Status indicators

There are four LEDs on the front of the MTL FNICO power supplies, and these can be used to establish the status of a system. The green LED, marked 'Pwr' (power) indicates that the voltage across the non-incendive trunk output is present, thus confirming that 24V input power is present and the power supply is functioning.

The red LED marked 'Fault' is lit when the current limit on the non-incendive supply is activated. The most probable cause is either a fault on the cable or attempting to operate too many field devices from the NI output. A quick initial check is to unplug the NI output and the power supply should recover.

The two yellow LEDs marked 'Host' and 'NI' are both permanently ON if the data chain on their respective trunks is healthy. If there are data communication errors these LEDs will either turn off or flash intermittently.

A satisfactory installation should have the green power LED and the two yellow signal monitors permanently ON, and the red fault LED extinguished. The power supply thus provides a good basis for the initial analysis of the status of the system.

The LED functions are summarised in Table 4:

Name	Illuminated	Extinguished	Intermittent
Pwr	NI trunk powered	NI trunk not powered	N/A
Fault	NI trunk in current limit	NI trunk OK	Intermittent current limit
Host NI	Data healthy Data healthy	Communications errors detected Communications errors detected	

Table 4 - LED indicators

3 CONNECTING FIELD DEVICES TO A FNICO POWER SUPPLY

3.1 Introduction

This section considers how to design a working system using MTL FNICO power supplies. The principal requirement is to ensure that there is an adequate voltage at the field device terminals for it to function correctly. The necessary calculation is a simple application of Ohm's law, using the power supply operational output voltage and output current, the cable resistance, the operating current of the field device and the minimum operating voltage of the field device. Each of these factors can be considered separately.

3.2 Output voltage and current

The minimum useable output voltage and current from the two FNICO power supplies are listed in Table 5.

Type number	Apparatus class	Useable output	
		Volts (V)	Current (mA)
9111-NI	IIC	12	180
9112-NI	IIB	12.8	320

Table 5 - Useable output from FNICO power supplies

The output current determines the maximum number of field devices that can be connected to the power supply, even with relatively short trunk installations. The output voltage determines the maximum trunk length.

Note: The output voltage specified is at 0°C, and is used in all subsequent calculations since it represents a reasonably conservative approach to the majority of installations. The power supplies have a positive temperature coefficient of 12mV/°C, which only needs to be considered if the power supplies are operated below 0°C. In these circumstances the reduced resistance of the trunk cable at lower temperatures has a counteracting beneficial effect.

3.3 Cable resistance

The FNICO technical specification requires cables to comply with the following parameters:

Parameter	Value
Loop resistance R_C	15Ω/km to 150Ω/km
Loop inductance L_C	0.4mH/km to 1mH/km
Capacitance C_C	80nF/km to 200nF/km
Max. length of each spur cable	30m in IIC and IIB
Max. length of each trunk cable	1km in IIC and 5km in IIB

Table 6 - FNICO cable parameters

These requirements must be met but usually are not a significant limitation since all commonly used instrument cable complies with the cable parameters specified. (Typically 50Ω/km, 0.8mH/km and 120nF/km). Occasionally the limitation on spur length is a slight inconvenience but this can be usually overcome by careful positioning of the field junction box. The FOUNDATION™ Fieldbus specification puts some limits on cable length, which includes the total length of the trunk plus the length of spurs.

Conventional existing wiring may prove adequate for fieldbus installations. Where specialist cable is installed it is designed to meet the 100Ω characteristic impedance requirement and is usually a screened, balanced, multi-stranded twisted pair. The American version is normally seven strands of 18 AWG, which has a loop resistance slightly less than 50Ω/km. The European version is of similar multi-strand construction, equivalent to 1mm in diameter, having a maximum resistance of 44Ω/km (at 60°C). For the purpose of calculation examples in this application note, a cable resistance of 50Ω/km is used, as this is a reasonably and practical figure.

3.4 Field device, voltage and current

FOUNDATION™ Fieldbus devices are required to operate satisfactorily with an average of 9V at their terminals. It is desirable to have a small margin above this, but the example calculations use this minimum figure.

The standing current required by field devices varies considerably. A survey of currently available devices suggests a range from 10 to 28mA with the majority requiring slightly less than 20mA. The number of devices which can be powered from a given source is largely determined by the current required and even a small change can have a significant effect on the length of cable permitted or the number of devices which can be connected. Where possible, the actual current consumption of the field devices in a system should be used to determine its acceptability. A figure of 20mA per device is used in the illustrative examples since this gives a cautious answer.

If the average current required is reduced from 20mA to 15mA per device, the number of devices that can be connected to the 9111-NI (IIC) power supply increases from nine to twelve, and from sixteen to twenty-one for the 9112-NI (IIB) supply. This does not change the useable trunk length significantly.

Figure 3 and Figure 4 illustrate the idealised voltage and current waveforms on the terminals of a field device. It is the average value of the current drawn that is relevant to the power supply performance. Similarly it is an average voltage of 9V which is required at the field device terminals.

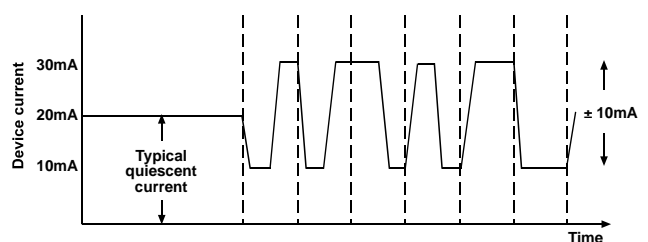

Figure 3 - Idealised current waveform of field device

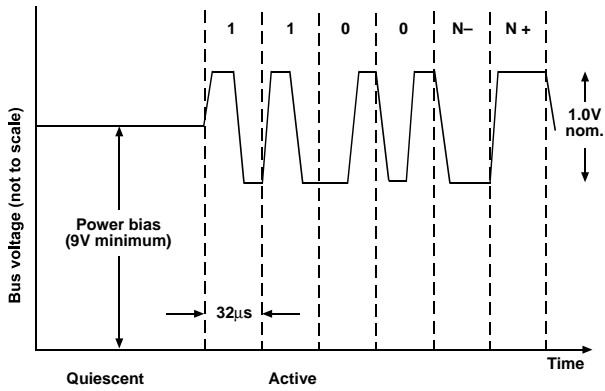

Figure 4 - Idealised voltage waveform of field device

For the majority of field devices the average current and the quiescent current are the same value. However when the quiescent current is below 10 mA the transmitting current is asymmetrical about the quiescent current and the average current rises to approximately 10mA. This phenomenon is illustrated in Figure 5 and should be taken into account when calculating the viability of a system utilising low current devices. The increase in current is only relevant to the one active device in a system, and can be taken into account by adding 10mA to the total current consumed by the system.

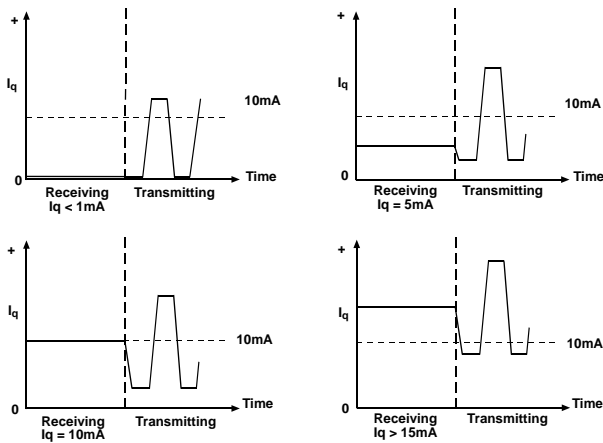

Figure 5 - Field device current waveforms

3.5 Typical calculation for IIC (9111-NI) power supply

The information necessary to be able to calculate whether a system will operate is the average current drawn by each of the field devices, and the resistance of the trunk cable.

A configuration that is frequently used and is a simple illustration of the necessary calculation to determine operational capability is shown in Figure 6.

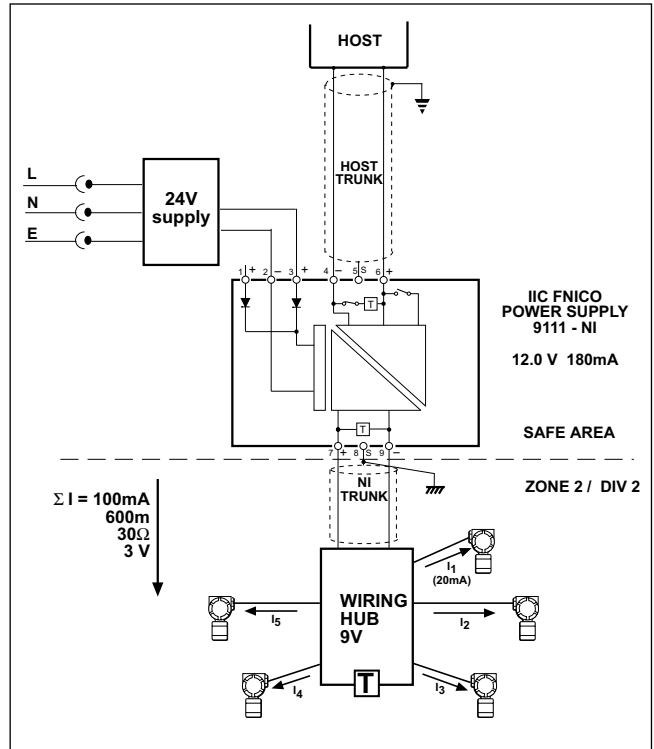

Figure 6 - IIC FNICO power supply with five field devices at end of NI trunk

Figure 6 illustrates a system with five field devices on spurs at the remote end of the non-incendive trunk. The first requirement is to ensure that the total current requirement of the field devices is not greater than the output capability of the power supply (180mA). If it is assumed that each field device requires an average current of 20mA then the maximum number of devices that can be powered from the IIC power supply is nine. The calculation of the maximum acceptable length of the IS trunk is then as follows:

$$\text{Acceptable voltage drop in trunk} = \text{Supply voltage} - \text{Minimum operating voltage of field devices}$$

$$= 12V - 9V$$

$$= 3V$$

$$\text{Total current in trunk} = \text{Number of field devices} \times \text{Average current per device}$$

$$= 5 \times 20\text{mA}$$

$$= 100\text{mA}$$

$$\text{Maximum resistance of trunk} = \text{Acceptable voltage drop} / \text{Total current in trunk}$$

$$= 3 / 0.1$$

$$= 30\Omega$$

$$\text{Maximum length of trunk} = \text{Maximum resistance of trunk} / \text{Resistance per km of trunk}$$

$$= 30 / 50$$

$$= 0.6 \text{ km (600m)}$$

The spurs are restricted to 30m by the FNICO technical specification and hence have a resistance of less than 1.5Ω and produce a voltage drop of 30mV when carrying 20mA. Except in the cases where the wiring hub contains voltage-dropping components, the voltage drop in the spur can be ignored and hence the system will work if the trunk is less than 600m long.

A similar calculation can be made using a different number of field devices, or devices using different currents. The two criteria to be applied are that the total current drawn must not exceed 180mA and the voltage drop on the trunk must not exceed 3V. For example, the trunk lengths corresponding to four and three devices are 750m, and 1000m respectively. Assuming that all the devices are at the remote end of the trunk gives a simple calculation and a pessimistic answer, which ensures that the system will work. It is prudent to do this calculation first and only resort to doing the more precise calculation if the simple calculation gives an unsatisfactory answer.

There are a large number of variations on the interconnection of field devices to the trunk and the operational requirements can always be analysed by the application of Ohm's law. Figure 7 illustrates a possible configuration and demonstrates that if some of the field devices are moved closer to the power supply then the permissible length of the trunk increases. If the devices are distributed along the trunk, the voltage drop on each section decreases as the total current carried by that section of the trunk decreases. The resultant pattern that emerges is illustrated on the diagram and the total trunk length increases to 750m.

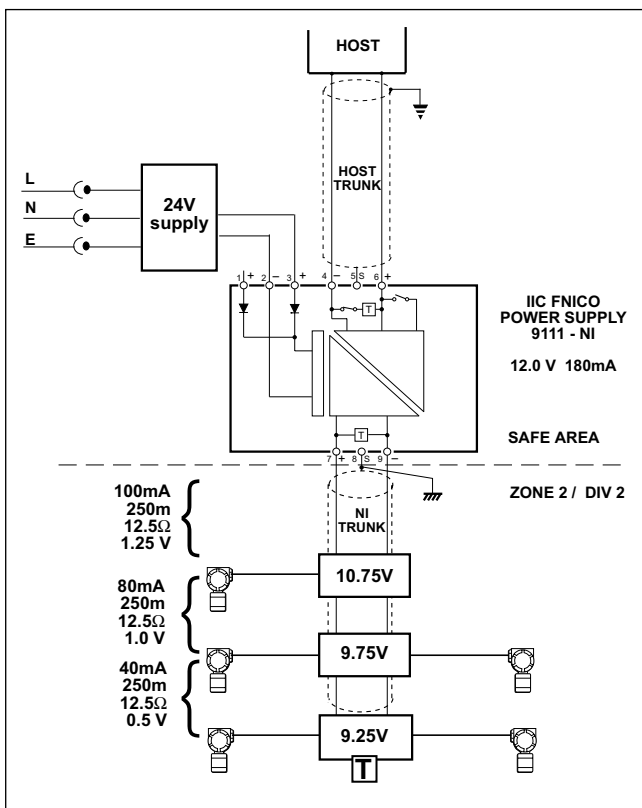

Figure 7 - IIC FNICO power supply with five field devices distributed along length of NI trunk

3.6 Typical calculation for a IIB (9112-NI) power supply

The IIB power supply has minimum output parameters of 12.8V and 320mA at 0°C for operational purposes. If the assumptions of the previous calculations are applied then the maximum number of field devices that can be supplied is sixteen. When eight devices are concentrated at the remote end of the trunk as indicated in Figure 8 then the calculation follows the pattern of Figure 6 and the available voltage drop on the trunk is 3.8V, and the permitted trunk length is 316m.

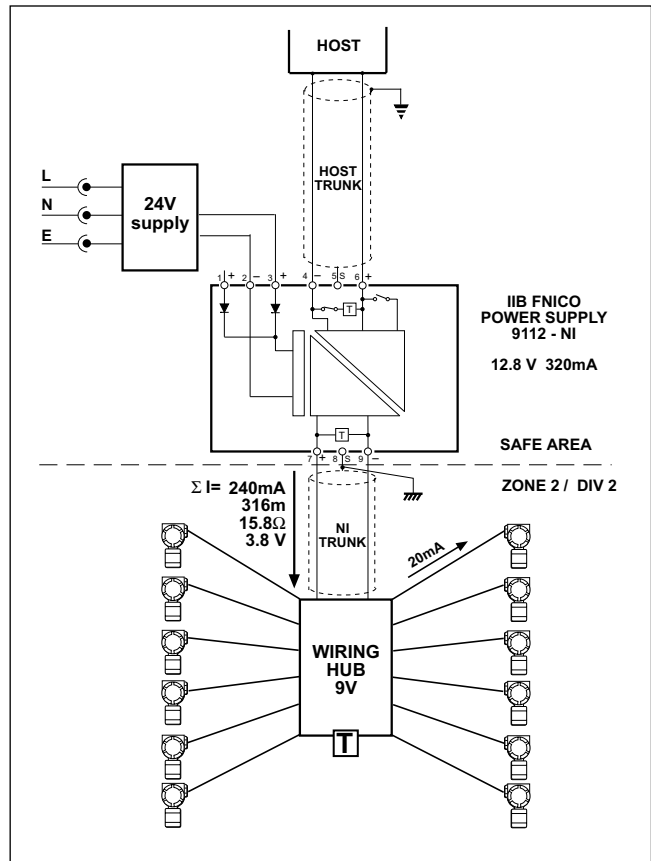

Figure 8 - IIB FNICO power supply with twelve field devices at end of IS trunk

An increased trunk length becomes available if the number of field devices is reduced, and the pattern shown in Table 7 emerges.

Number of field devices	Length of NI trunk (m)
4	950
5	760
6	633
7	542
8	475
9	422
10	380
11	344
12	316
13	292
14	271
15	253
16	237

Table 7 - Relationship between trunk length and number of devices

There are a very large number of possible combinations of field devices with the IIB power supply. It is probable that the simple calculation assuming that the devices are concentrated at the end of the trunk will give a satisfactory answer, which ensures that the system will work. A more detailed calculation taking into account the different voltage drops can be made if this proves to be necessary.

Figure 9 illustrates this type of calculation with the field devices split into two groups of six with one group 200m along the trunk, and the second group positioned a further 200m along the trunk.

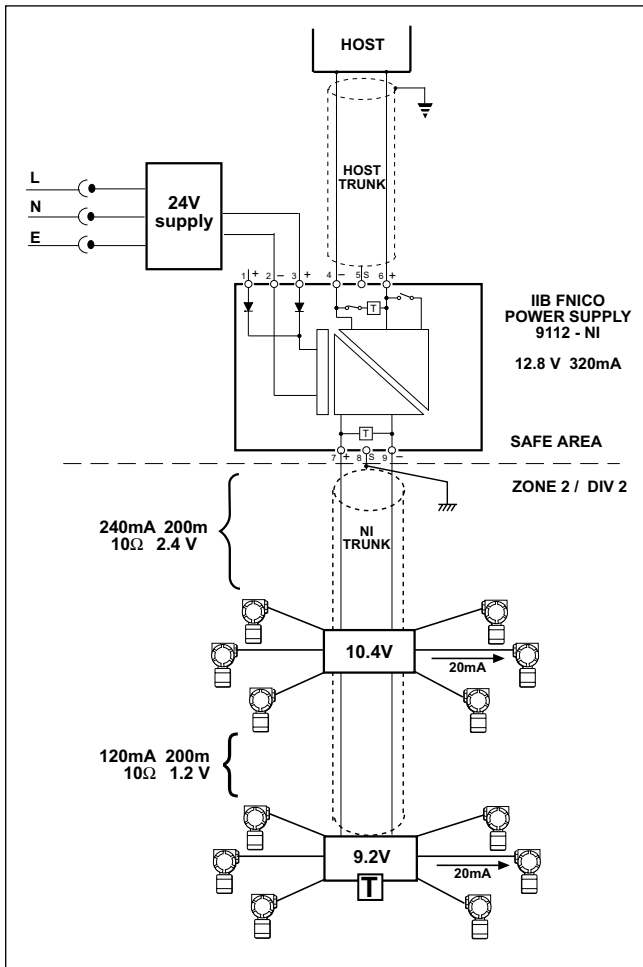

Figure 9 - IIB FNICO power supply with twelve field devices split into two nodes on the NI trunk

The first 200m of the trunk carries the current for all twelve devices (240mA through 10Ω) and drops 2.4V, which gives a minimum voltage of 10.4V at the first node. The second part of the trunk carries 120mA and drops a further 1.2V giving a minimum voltage of 9.2V at the final node. This is adequate and hence the system is operationally satisfactory.

4 COMMISSIONING AND FAULT FINDING IN A FNICO SYSTEM

4.1 Introduction

A major advantage of a non-incendive system is that it may be worked on in a hazardous area without switching it off, or obtaining a gas clearance certificate. The permitted maintenance procedure for a non-incendive system is not clearly defined in IEC/EN 60079-17 but since the non-incendive technique is similar to that of intrinsic safety (without taking faults into consideration) it is reasonable to adopt the procedures for intrinsic safety. Clause 4.8.2 of IEC/EN 60079-17 details the permitted activities for IS circuits. These are the removal and replacing of apparatus and modules and the use of appropriate test equipment. This enables the diagnosis of faults and their correction to be accomplished quite readily.

In North America, live working is permitted on non-incendive circuits, on the basis that normal operation includes typical maintenance activities. Clause A.7.3 of ANSI/ISA-12.12.01-2000 states,

“Normal conditions for non-incendive circuits include opening and closing of contacts, adjustments, operation at the maximum pressure etc. Normal conditions for non-incendive wiring include opening, shorting or grounding of field wiring.”

It is not a practical proposition, nor is it permitted, to carry out detailed fault finding on the apparatus within a non-incendive circuit when it is in, or connected to, the hazardous area. Major repairs to any non-incendive apparatus may affect the level of safety provided and invalidate the certification. In general, only the manufacturer or his authorised representative should effect repair.

It is usual to use intrinsically safe test equipment on non-incendive circuits since this equipment is available and can be used without a gas clearance certificate. Theoretically test equipment certified as non-incendive can be used but this may not be commercially available.

This section assumes that the power supply is mounted in a safe (non-hazardous) area. When the power supply is used in a Zone 2 or Division 2 location then the procedure is slightly modified, as discussed in Section 10 of this application note.

4.2 Facilities

The MTL FNICO power supplies have system status indicators to aid fault diagnosis, as already described in Section 2.6. A further useful feature is that all the interconnections are made using plug in terminals, which makes disconnection and correct reconnection relatively easy. The plugs are designed to fit securely, and should be removed using a small screwdriver as a lever as illustrated in Figure 10. (The Zone 2 and Division 2 standards require the plugs and sockets to have a considerable extraction force and this is also desirable from an operational reliability viewpoint). A spare set of plugs for the FNICO power supply makes testing of the power supply and reconnection of the existing wiring easier. A single plug with the polarising strips removed will fit into any of the sockets but this could lead to subsequent misuse and the utilisation of a full set of plugs is the recommended practice.

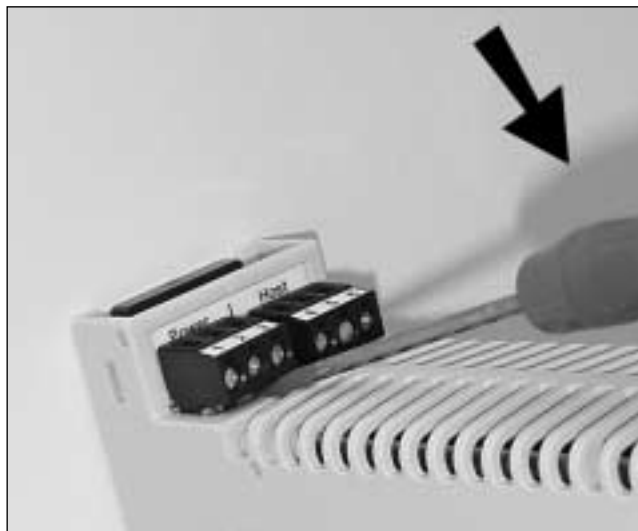

Figure 10 - Disconnection of FNICO power supply terminal block

A simple resistance check on each installed cable before connecting it to equipment is desirable since this can save a considerable amount of time. This is best carried out using a certified intrinsically safe tester, since this reduces the possibility of making an error when testing the cable in the hazardous area. There are a number of such testers commercially available.

The insulation checks on a screened twisted pair should be between the wires, from each wire to the screen, and from the screen to the structure. Values greater than 100 kΩ should be achieved on a new installation, but the system should operate with values above 10 kΩ. The insulation test is carried out at a low voltage but this is satisfactory for this purpose.

In addition the loop resistance of the cable should be checked by shorting one end of the pair. The acceptable value is determined by the value used in the calculation to demonstrate the feasibility of the intended interconnection of equipment. It should be remembered that copper has a relatively high temperature coefficient of resistance (+20% for 25°C rise) if the wiring is intended to be subjected to significant changes in ambient temperature.

4.3 Specialist test equipment

None of the available items of specialist test equipment is certified for connection to the non-incendive part of the circuit, without obtaining a gas clearance certificate. This test equipment can be used effectively on the safe area side of the power supply and to apply tests to the NI terminals when the non-incendive circuit is disconnected.

When connected across an active bus, the FBT-3 Fieldbus monitor checks:

- the voltage across the bus. (>9V).
- the signal level of the probe node frame from the Link Active Scheduler (>150mV).
- the number of devices on the network and also any additions or removals.
- the signal level and identity of the device with the lowest signal level (>150mV).
- the average noise level (<75mV).
- the peak noise level (<75mV).
- the signal level of a new devices response (150mV).

The monitored function is selected by scrolling through using the 'Mode' selection button on the front of the device. Although signal levels as low as 150mV are acceptable, they will typically be in the range 500 to 900mV.

The FBT-3 monitor draws approximately 10mA from the bus. The useable current figure quoted for the FNICO power supplies allows for 10mA being drawn as the inrush current when a new field device is added to the bus. There is therefore the possibility of a momentary problem if a device is added to a fully loaded bus while the FBT-3 monitor is connected.

The FBT-5 Fieldbus wiring validator supplies the power and a test signal so that when used with the FBT-3 the suitability of wiring to be used in a fieldbus system can be checked. It is unlikely that a newly installed cable using one of the fieldbus specified cables will cause any difficulty. However if an existing cable with less well-defined parameters is to be used, then a check of its transmission qualities is prudent.



Figure 11 - FBT-3 Fieldbus Monitor



Figure 12 - FBT-5

4.4 Procedure

It is not possible to write a fault-finding procedure that is applicable to all the possible configurations of a non-incendive system. The normal techniques of checking the power supplies and the presence of signals are applicable to fieldbus systems as it is to almost all other systems. This section suggests a possible way of checking some of the functions of the system. The host would usually first detect the failure of the system, and in some cases indicate which of the field devices is defective.

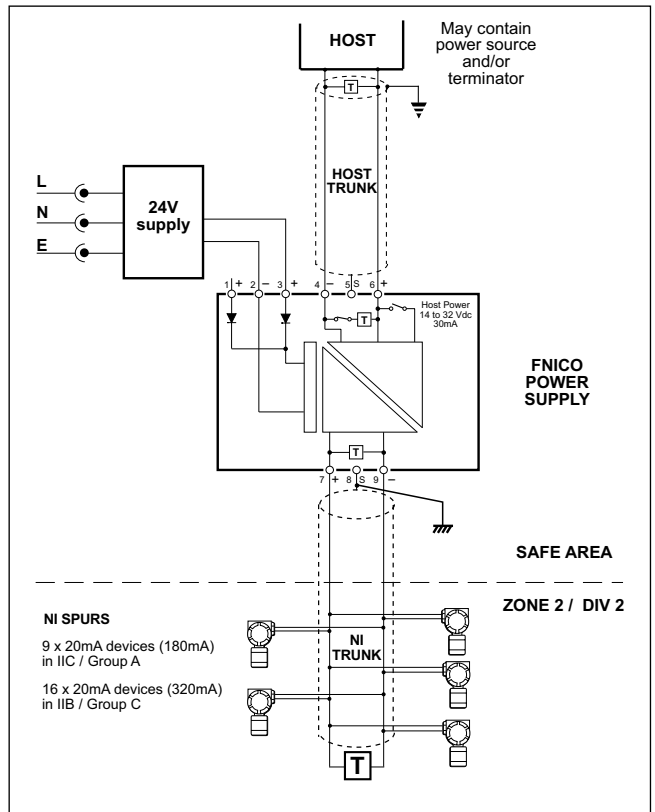

Figure 13 - Diagram of simple system

The following notes based on the simple system illustrated by Figure 13 may prove helpful:

4.4.1 24V supply check

Usually the 24V supply has some indication that it is present. In the specific case of the two MTL supplies normally used, the MTL 5991 and the 8914-PS-AC, both supplies have LEDs on the top surface of the unit, which indicate that the output power is present. If this indication is absent then the presence of the mains supply should be checked. If this is satisfactory then the load on the power supply should be removed by unplugging the 24V output terminals. If the LED indication reappears then the power supply is overloaded and the

power supply is probably not at fault. The presence of the 24V supply at the FNICO power supply input terminals can be checked by using the FBT-3 in the relevant mode or any other multimeter.

4.4.2 FNICO power supply

The LED indicators on the power supply enable its operation to be readily checked.

The green LED marked 'Pwr' is connected across the non-incendive output and should be ON at all times, indicating that the dc volts are present at the non-incendive trunk terminals. This can be confirmed by removing the non-incendive trunk plug and measuring the voltage with the FBT-3. It is important to disconnect the non-incendive trunk before using the FBT-3, since the FBT-3 is not suitably certified. Measurements on the connected non-incendive trunk can be made using one of the commercially available IS certified multimeters. The most common cause of the absence of voltage on the non-incendive trunk is the absence of the 24V supply to the input. This also results in all the indicators being off.

The red LED marked 'Fault' is illuminated when the supply to the non-incendive trunk goes into current limit. If disconnecting the non-incendive trunk plug extinguishes the LED, then the probable causes are a short circuit of the non-incendive trunk or attempting to supply too many field devices. Selective disconnection (usually conveniently done by unplugging at the connection block) of the field devices usually reveals the source of the problem. When first switched on the FNICO power supply may go into current limit as some field devices have a high starting current. Usually the system does start and the fault indication is removed as the line voltage recovers.

The yellow LED marked 'Host' is normally ON if the data on the host trunk is healthy. If there is a problem then the LED is either extinguished or flashes, depending on the nature of the fault. The FBT-3 can be used to assist in diagnosing the nature of the fault.

The yellow LED, marked 'NI', monitors the data on the non-incendive trunk in a similar manner, being normally ON, and flashing or extinguished if there is a fault. The FBT-3 should not be used on the non-incendive trunk, even within the safe area, without a gas clearance certificate, which covers the whole system.

An operational system should have a green LED and two yellow LEDs permanently ON and the red LED OFF.

If there is reason to believe that the FNICO power supply is defective then it can be further tested as follows. Disconnect the non-incendive and host trunks and apply the FBT-5 to the host trunk connection (with the host power supply switched OFF) and monitor the output on the non-incendive trunk with the FBT-3. The FBT-5 signal does not have the correct preamble signal and consequently the host yellow LED flashes intermittently, but the FBT-3 functions adequately indicating that the FNICO power supply is functional. The ability of the FNICO power supply to communicate in one direction is checked by this interconnection

Checking the communication from the non-incendive trunk to the host trunk is marginally more difficult. The FBT-5 does not function in the presence of a second source of power, and consequently cannot be applied directly to the NI trunk terminals. The interaction between the two sources of power can be removed by coupling the FBT-5 to the NI trunk terminals via a capacitor and providing a separate resistive load to the FBT-5. The recommended practice is to couple the positive output from the FBT-5 to the positive NI trunk terminal via a 1µF non-polarised capacitor and load the output terminals of the FBT-5 with a 1kohm resistor. The two negative terminals should then be directly connected. The FBT-3 should be connected to the host terminals, with the host power supply switched in. If the communication facility of the FNICO power supply is functioning then this should be confirmed by satisfactory readings on the FBT-3.

4.4.3 Field devices

The host will normally provide a facility for listing the status of the field devices if the fault in the device does not pull down the whole net-

work. If the network fails then the problem can usually be isolated by systematically disconnecting sections of the NI trunk. This is readily accomplished when the system uses Relcom Megablocks, which use plug in terminals. Where such a connection has an unused connector, this provides a useful point for monitoring the trunk voltage.

The majority of field devices have built in diagnostic tests, which can be addressed by the host. Consequently their failure can be quickly diagnosed and their isolation and removal readily accomplished. It is advisable to disconnect the field device spur at the connection block so as to remove the risk of shorting out the IS trunk during the maintenance operation.

4.4.4 Non-Incendive Trunk

If it is thought desirable to measure the voltage and current in the IS trunk or its spurs, or their isolation from ground, this should only be done using a suitably approved multimeter. The use of the FBT-3 across the host trunk can yield useful information but the signal and noise level measurements are affected by their transition through the FNICO power supply and hence should be interpreted with that in mind.

4.4.5 Host and host trunk

The FBT-3 will usually provide all the information necessary to find any fault in the host trunk, which is usually only a simple interconnection. If the host develops a fault then the diagnostic procedure of the particular host should be followed. The use of the FBT-3 across the host trunk can yield useful information but the signal and noise level measurements are affected by their transition through the FNICO power supply and hence should be interpreted with that in mind.

5 FNICO INSTALLATION REQUIREMENTS

5.1 General

The installation requirements described in this chapter are intended to cover the common situation when the power supply is mounted in the safe area (see Figure 14) and the less usual situation when the power supply itself is mounted in Zone 2 or Division 2, as described in Section 10.

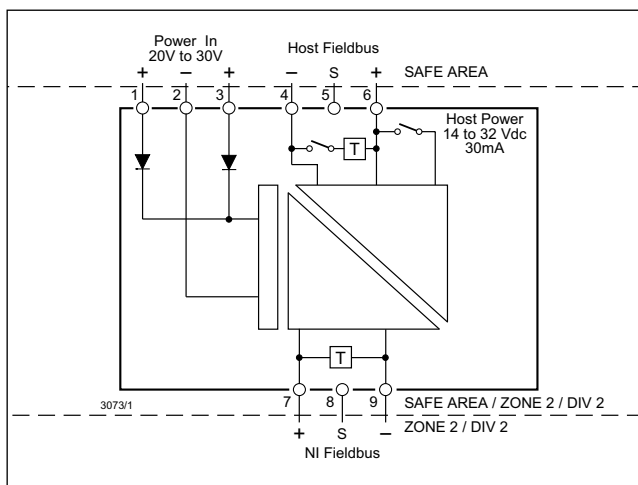

Figure 14 - Field location of FNICO power supply

5.1.1 IEC Zone 2 installations

Installations in IEC Zone 2 hazardous areas should follow the guidance given in the IEC code of practice IEC 60079-14. This section makes proposals that are particularly relevant to a FNICO installation and is intended to supplement, not to replace that document.

5.1.2 North American Division 2 installations

Installations in North American Division 2 hazardous locations should comply with the latest edition of the National Electrical Code,

ANSI/NFPA70, and with ANSI/ISA-12.12.01-2000, "Nonincendive Electrical Equipment for use in Class I and II and Class III, Divisions 1 and 2 Hazardous (Classified) Locations".

An important consideration is the exception to Section 501-4 (b) of ANSI/NFPA 70:1999, which states, "Nonincendive field wiring shall be permitted using any of the methods suitable for wiring in ordinary locations." This exception is intended to permit what is also described as "nonincendive field wiring" in ANSI/ISA-12.12.01-2000.

The Factory Mutual installation drawing included in Appendix IV gives some specific guidance.

5.2 Cables

There are three types of cable involved in a FNICO installation, which require special consideration. These are:

5.2.3 The non-incendive trunk and spurs

The choice of cables for use with fieldbus signals is not restrictive, and frequently existing cables can be used thus reducing installation costs. Where a 'gas clearance certificate' can be obtained the suitability of an existing cable can be checked by using the combination of the FBT-3 and FBT-5 testers as discussed in Section 4. There are a number of cables specifically designed to carry the 31.25 kbit/s signal which usually follow the specification of the cable used in the conformance testing of fieldbus circuits. This is a 'single twisted pair cable meeting the following minimum requirements at 25°C.

- impedance at fr (31.25 kHz) = $100\Omega \pm 20\%$
- maximum attenuation at 1.25 fr (39 kHz) = 3.0 dB/km
- maximum capacitive unbalance to shield = 4nF/km, tested using a 30m or longer sample
- maximum d.c. resistance (per conductor) = $24\Omega/\text{km}$
- maximum propagation delay change 0.25 fr to 1.25 fr = 1.7 ms/km
- conductor cross sectional area (wire size) = 0.8 mm^2 (#18 AWG)
- minimum shield coverage shall be 90%

The MTL FNICO Technical Standard requires that the non-incendive trunk should have the following parameters:

Parameter	Value
Loop resistance, R_c	15 Ω /km to 150 Ω /km
Loop inductance, L_c	0.4mH/km to 1mH/km
Capacitance, C_c	80nF/km to 200nF/km
Max. length of each spur cable	30m in IIC and IIB
Max. length of each trunk cable	1km in IIC and 5km in IIB

Annex B of IEC 61158-2 discusses suitable cables for H1 applications. It also makes recommendations on trunk and spur lengths, which are likely to result in a system which operates satisfactorily from a noise and interference viewpoint. The limits proposed are based on practical experience, and systems which stretch these limits may be satisfactory. However with all digital systems it is extremely difficult to determine when a system is operating with an adequate margin from its point of failure, and when a digital system fails intermittently finding the fault is difficult. It seems prudent therefore to work within the limits proposed by IEC 61158-2 in addition to the limitations required by the FNICO standard.

The Annex B proposes four types of cable of which the type 'A' cable is as specified above and permits a trunk length, including all the spurs of 1.9km. This type of cable will be used on almost all new installations. The maximum length of a trunk in IIC permitted by the FNICO standard is 1km (not including the spurs) and this determines the maximum length for IIC applications. For IIB installations the operational limit of 1.9km is the determining factor for permitted trunk

length. In practice the maximum trunk length is frequently decided by the requirement to have a minimum voltage of 9V available at the field device (see Section 3).

A type 'B' cable is a multiple twisted pair cable with an overall screen (shield) with the same specification for each pair as a type 'A' cable. This cable could be used as the fixed multicore where multiple fieldbuses are run to the same area of a plant and the recommended maximum trunk length is 1.2 km. IEC 60079-14 requires that fixed multicores of this type used for IS circuits should have a minimum insulation thickness requirement of 0.2mm and withstand a 1kV voltage test. It is expedient to apply these same criteria to non-incendive circuits since the available cables satisfy these requirements. A trunk using a type 'B' cable is therefore restricted in length to 1km in IIC and 1.2 km in IIB.

A less preferred cable is a single or multiple twisted pair cable without any screen, known as a type 'C' cable. This type of cable is usually used when an existing cable is pressed into service for a fieldbus installation. The maximum recommended length of trunk using this cable is 400m in all circumstances, and the FNICO limitations do not influence the decision.

The least preferred cable is the type 'D' cable, which is a multiple conductor cable without twisted pairs or screening. This type of cable is only used as a last resort and its recommended trunk length is restricted to 200m (including the spurs) in all circumstances.

IEC61158-2 also contains some proposals on restricting spur lengths, which vary with the number of devices on the trunk, and the number of devices on the particular spur. The FNICO standard restricts the spur length to 30m. The normal maximum number of field devices is restricted to 16 (determined by the capability of the host or the current available from the power supply, not by the FNICO standard). Consequently the number of devices permitted on a spur is four, which reduces to three if there are 12 or 13 field devices connected to power supply, and two if there are 14 to 16 devices connected.

A typical instrument cable has parameters of 50 Ω /km, 0.8mH/km and 120nF/km and almost all instrument cables fall within the permitted parameters required by the FNICO standard. All cables for use in hazardous areas have to satisfy the requirements of clause 9 of IEC 60079-14. For example they must have adequate fire retardant properties and resistance to chemical attack. In addition some installations require a special specification to meet the specific requirements of the particular installation, such as where extremes of temperature are anticipated.

There are a number of manufacturers who supply cable specifically designed for use with fieldbus instrumentation, and suitable for use in Zone 2 or Division 2 locations. Two of the many are Belden Wire and Cable Company (www.belden.com) and Lapp Cable (www.lappcable.com).

The use of a screened cable removes the necessity for segregation of the non-incendive trunk from other cables for safety reasons. Normally segregation is desirable to ensure that interference problems are minimised and clear identification of the cables is possible.

In practice the requirements for operational reliability are more onerous than the ignition safety requirements and any installation which is adequate from a reliability viewpoint will satisfy the Zone 2 installation requirements.

5.2.2 The host trunk

Where the power supply is located in the safe area the host trunk is safe area wiring and needs only to comply with the requirements of fieldbus cable set out in the previous section but the restrictions of the FNICO standard do not apply.

Where the host trunk is located in the Zone 2 or Division 2 then it is probably considered to be non-arcng because the connection to the host is not defined as non-incendive. Ideally the host port should be defined as being suitable for connection to a non-incendive circuit and then a non-incendive host bus could be used, but this rarely hap-

pens. The requirements of the non-arcing cable are not significantly different from those of the non-incendive trunk, except that because a damaged cable can produce an incendive spark, more attention must be paid to avoiding the possibility of mechanical damage. Usually the cables are adequately protected by cable trays or other means of support and it is the 'tail' to the instrument, which is the most vulnerable section. It may be considered necessary to protect this section by using flexible conduit or some other technique.

The terminals used on the host trunk connection of the power supply are suitable for connecting a non-arcing circuit.

There is a requirement that the cable should be protected from electrical overload, which in other installations, is usually done by installing a fuse in all the conductors. However this is not an appropriate technique for this application and it is usual to rely on the current limitation in the host and power supply. Similarly the cable should be provided with a means of isolation (presumably at both ends) for maintenance purposes. Isolation is usually accomplished by unplugging the terminal at the power supply, which is a permissible action since the current broken by this action is normally non-incendive. In the majority of installations the connection to the host is also taken via a plug and socket which provides the necessary means of isolation.

The major disadvantage of using a non-arcing trunk is that because 'live-working' is not permitted faultfinding is more difficult.

5.2.3 The mains power supply cable

When the power supply is mounted in Zone 2 or Division 2 it is usually in a suitable enclosure together with a mains to 24V power supply. The cable carrying the mains supply must be installed in accordance with IEC 60079-14, and is usually a cable with a toughened outer sheath or some form of armouring. It must be provided with a means of isolation and some form of protection against electrical overload.

Where a means of isolation is considered to be desirable in the hazardous area then this can be achieved by using the flameproof MTL 951 plug and socket, which is suitable for this purpose.

6 ESTABLISHING SAFETY COMPATIBILITY BETWEEN FIELD DEVICES AND FNICO POWER SUPPLIES

6.1 Intrinsically safe field devices

6.1.1 Background

It is desirable to be able to use intrinsically safe field devices with FNICO power supplies in a non-incendive system for a number of reasons. The principal reason is that the standardisation on one type of device for both FISCO and FNICO applications has advantages in purchasing negotiations and stock holding for spares. A further advantage is that the possibility of making errors in the selection of apparatus on initial installations or when making substitutions is reduced. The availability of intrinsically safe certified field devices is likely to be higher than non-incendive devices at least for some time and it is desirable to maximise the available choice. From the manufacturer's viewpoint having only one instrument to manufacture which serves both purposes will probably be a more significant factor than the small reduction in component costs, which might result from making two separate devices. In the long term the devices may be marked as being suitable for both purposes but this will take a few years, and there will always be some exceptions.

This section defines the checks necessary to establish that IS fieldbus apparatus may be safely used in a FNICO system.

6.1.2 Safety compatibility

When a field device is used in a FNICO circuit then it is assessed under normal operating conditions, with a few additional requirements derived from the type 'n' standard IEC 60079-15, or Factory Mutual Standard 3611, as appropriate. The constructional require-

ments of the type 'n' standard for energy-limited apparatus (nL) are less onerous than those of the intrinsic safety standard and hence IS apparatus does not need to be reassessed for compliance with the constructional requirements of nL apparatus. The enclosure requirements for IS apparatus are not as specifically defined as for type 'n' apparatus but the requirement that the apparatus be adequately protected from the environment either by its own or an additional enclosure ensures that it is adequate for Zone 2 applications.

Since non-incendive apparatus is assessed in normal operation, then the current drawn and the power used are determined by the field device and not by the current and power available from the non-incendive trunk. For this reason the permitted input current (I_i) and the permitted input power (P_i) parameters of the IS apparatus are not relevant to its non-incendive application, and compatibility can be determined from the voltage parameters alone. The non-incendive I_o and P_o values of the FNICO power supply may therefore exceed the IS input parameters I_i and P_i of the field device without invalidating the safety analysis of the non-incendive system. The acceptable values of I_o and P_o for the power supply are determined by the requirement to be non-incendive when the interconnecting cable is subject to fault.

6.1.3 Worked example

Consider the example where an IS field device has input parameters of U_i : 24V, I_i : 250 mA and P_i : 1.2W and is connected to a FNICO power supply which has non-incendive output parameters of U_o : 14.8V, I_o : 380mA, P_o : 5.62W. The current drawn by the field device in normal operation is always smaller than the permitted IS input current, typically less than 20mA, which in this specific case corresponds to an input power of 300mW. Consequently, because only normal operation is considered, the IS input parameters for current and power of the field device are not relevant to the safety assessment of the non-incendive system. The only relevant parameter is the permitted input voltage U_i which must be not less than the output voltage U_o of the power supply, and in this specific example this requirement is satisfied.

The levels of current and power normally encountered with non-incendive fieldbus field devices are 20mA and 350mW respectively and consequently a T4 temperature classification at 70°C is readily justified. The temperature classification of the apparatus for IS certification will always have been done at higher power levels and consequently this classification can also be used for non-incendive applications.

There is also no problem with the voltage rating as FNICO power supplies are required by the FNICO Technical Specification to have a maximum voltage of 17.5V; consequently, any FISCO certified device will be acceptable for use with a FNICO power supply. Where a fieldbus device has been certified to the original FOUNDATION™ Fieldbus specification it is certified with a permitted input voltage (U_i) of 24V and hence can be used in a FNICO system. Similarly all the other fieldbus devices (known to MTL), which have been certified IS have permitted input voltages higher than 17.5V, and provided that this parameter is checked they are acceptable for use in a FNICO system.

The permitted effective input capacitance (C_i) and input inductance (L_i) of 5nF and 10μH respectively are the same for both FNICO and FISCO field devices. Consequently any device certified to the FISCO standard satisfies the FNICO requirements in this respect. Devices certified as intrinsically safe to other standards should be checked to ensure that they comply. The exception to the 10μH rule is that field devices certified to the FOUNDATION™ Fieldbus FF-816 standard, which have a residual input inductance of 20μH, are acceptable. The basis for this exception is that the current flowing through an individual device in normal operation will never exceed its rated current consumption. If this is assumed to be, say, 40mA, then the resulting stored energy is 0.016μJ, calculated from $\frac{1}{2} L I^2$, which is acceptably safe in any gas.

The IS certification of the field device will ensure it cannot add voltage or current to the non-incendive trunk either from its own internally stored energy, or from any other source of power which may be

applied to it. The IS certification also ensures that the non-incendive trunk is galvanically isolated from any other source of power and from earth.

6.1.4 Summary

To summarise, the compatibility of an IS fieldbus field device can be established by asking the following questions:

a) Is the apparatus certified to the FISCO Technical Specification or FOUNDATION™ Fieldbus standard FF-816? If it is, then it is compatible, if not move to question b)

b) Is the apparatus certified intrinsically safe with a permitted input voltage not less than 17.5V and its Ci and Li not greater than 5nF and 20μH respectively? The apparatus is acceptable if it meets these requirements. If not, it is not acceptable to the MTL standard, and if used must be justified by some special argument, which must be fully documented.

6.2 Non-incendive field devices

For North American Division 2 applications, field devices having non-incendive approval may be used. Such devices must be approved with 'non-incendive field wiring parameters', which indicate that the devices have been considered for connection to energy-limited circuits. This type of approval is evident from the presence of field wiring parameters Vmax and Imax in the approvals listing, together with the normal approvals code in the typical form NI/1/2/ABCD/T4.

In the same way as for intrinsically safe devices, compatibility between the FNICO power supply and the field device may be established by comparing only the voltage parameters. Where Vmax for the field device is greater than or equal to Vo for the power supply, safety is confirmed. Note however that the internal inductance and capacitance must also be considered, as described in 6.1.4 (b) above.

This procedure is further confirmed in the Clause 2 of the Installation Drawing which accompanies the Factory Mutual approval of the FNICO power supplies, as reproduced in Appendix IV.

Where a field device carries intrinsically safe and non-incendive approval, the published approvals listing may not state any non-incendive field wiring parameters, even though the device is suitable for connection to energy-limited Division 2 wiring. In this case the IS 'Entity' parameters may be used for the assessment.

6.3 EEx nL devices

For IEC Zone 2 applications, field devices carrying approval to type of protection 'n' may be used. Such devices must be approved Ex nL, where the 'L' confirms suitability for connection to energy-limited wiring. In this case, the certificate will state maximum input parameters Ui and li.

Note that the requirement to consider cable capacitance in Zone 2 energy-limited circuits, as described in Clause 14.2 of IEC 60079-14, does not apply to FNICO installations.

6.4 Terminators and connecting blocks

The use of IS accessories such as terminators and connecting blocks in non-incendive circuits is usually without any significant problems, but does require a little thought. For example the IS versions of the Relcom Megablock (FCS-MB4-IS and FCS-MB8-IS) are capable of carrying the short circuit current of the IIB FNICO power supply (500mA) without any degradation of the insulation or temperature classification problems being caused by overheating. The terminals and construction are such that a rating of 1.5A can be justified, and therefore there is no problem.

The FISCO terminator FBT1-IS is not sensitive to current or input power under the 'normal operation' conditions of non-incendive circuits, and can therefore be used in IIC T4 FNICO circuits.

6.5 Marking of IS devices used in a FNICO system

It is recommended that where IS apparatus is used in a FNICO system then its application should be clearly identified by the use of a suitable plant label. The precise form of such a label will vary from installation to installation, but Figure 15 is a representative sample.

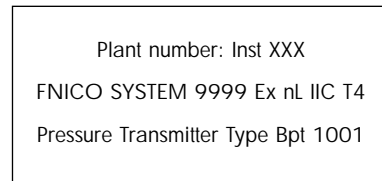

Figure 15 - Typical plant label

The system number provides an adequate lead to the safety documentation, which should provide all the necessary information. Almost all fieldbus field devices provide sufficient intelligence to enable automated links to the necessary safety information without difficulty. It can be argued that nothing more than a clear plant number, which leads to the safety documentation, is necessary. The MTL proposal is a compromise between this simple approach and trying to write a label, which contains all the safety information. As always the final decision rests with the system designer and the final end-user.

It is not recommended that the IS certification label of the field device is defaced or removed since this reduces the traceability of the device and removes some of the information on which the safety assessment is based.

6.6 Re-use of intrinsically safe field devices

The question is sometimes raised as to whether IS apparatus which has been used in circuits which are not IS such as non-incendive or safe area circuits can subsequently be used in IS circuits. The perceived problem is that use in the non-IS circuits could cause damage, which is not self-revealing but would reduce the level of protection offered by the original IS certification. The question normally arises because it is common practice on most petrochemical installations to purchase a single type of instrument, for example a pressure transmitter, for use in all locations on a plant. An IS transmitter can then be used on a temporary installation in a safe area in a conventional safe area loop, and after some time be returned to the store as a spare instrument. From the store it could be used to replace a defective instrument in an intrinsically safe loop.

It can be assumed that the replacing instrument is functional, and not mechanically damaged (the majority of instrument technicians would check this in the workshop before putting the instrument in the stores as a spare) and therefore the concern is that there is some fault which reduces the IS integrity but does not affect the operation of the instrument. Almost all faults from an external source would cause sufficient damage to the apparatus for it to malfunction, rather than cause the conservatively rated safety components to fail to danger without damaging any other components. This type of undetected failure is just possible but is sufficiently improbable to be ignored. In the particular case of a non-incendive installation then the selection of apparatus, and the installation code followed further reduce the probability of the IS apparatus being stressed.

There are a number of circumstances where a similar risk occurs, and the risk is considered acceptable. A very clear example is that the IEC standard on inspection and maintenance, IEC 60079-17 permits the use of non-certified test equipment under 'gas clearance certificate' conditions. Similar risks are accepted during faultfinding procedures in instrument workshops. There are also significant risks of such faults occurring during the repair procedures permitted by the IEC standard on repairing this type of apparatus IEC 60079-19. The test equipment used in the final stages of manufacturing of IS equipment is not designed to be fault tolerant and could produce undetected faults. These risks illustrate the point that where a risk is small it can be, and is accepted.

The conclusion is therefore that the IS status of a field device is not changed provided that the device is functioning correctly and is not mechanically damaged after being used in a non-incendive circuit. If these two requirements are met the field device can be used in an IS circuit without further consideration.

7 EARTHING

7.1 Introduction

The IEC code of practice IEC 60079-14 does not contain any specific requirements for earthing or bonding of Zone 2 installations and hence this document follows the general recommended practice for Zone 1 and Zone 2. The recommendations for non-incendive circuits are drawn from the requirements of IS circuits because of the similarity of the two techniques.

The recommendations in this section are applicable to the usual hazardous location where the plant is well bonded and the source of electrical power is referenced to the resultant equipotential plain, thus ensuring that major potential differences between different parts of the fieldbus circuit cannot occur. Where a fieldbus circuit is used to transfer information between areas which have different reference potentials then these installations require special consideration. This situation usually arises when the fieldbus information is transmitted from a plant to a remote computer. A solution is possible using the MTL power supply as a repeater and taking advantage of the isolation between the two trunks of the system.

7.2 Trunks

A fieldbus trunk is intended to be operated as an isolated balanced system so as to minimise the problem of interference. The MTL FNICO power supply produces trunks that are isolated from the ground, the 24V source of power and each other. This three port isolation together with the pulse reshaping which occurs within the power supply as the signal is transferred between the trunks ensures that any interference problems are minimised. If an earth fault to one wire occurs on one of the trunks then this almost always increases the interference level on the trunk. The unbalanced trunk may continue to function, fail intermittently or completely. It is impossible to predict what will happen, but intermittent failure is the usual consequence. The isolation within the power supply prevents interaction between earth faults within the system and simplifies the procedure for detecting such faults.

7.3 Screens/shields

It is usual to use screened twisted pair cables for the trunks since this minimises the interference problem and allows longer trunks to be used with confidence. It also has the merit of removing concerns about faults occurring between the non-incendive trunk cables and other cables.

There are two schools of thought on the subject of earthing of screens from an operational viewpoint, and these views are held with an almost religious fervour which makes convincing anyone to consider the relative merits of the other argument almost impossible. To oversimplify the arguments, the technique that bonds one end and isolates the other prevents circulating currents in the screen and optimises the rejection of low frequency interference. Bonding the screen at both ends and at intermediate points produces better rejection of high frequencies. H1 fieldbus sits in the middle of these two extremes (31.25 kbits/sec) with perhaps a tendency to be more adversely affected by high frequencies. A possible solution which meets both requirements is to bond one end of the screen and bond the other end and some intermediate points to ground via a small capacitor (1nF, 1500V ceramic). The disadvantage of this technique is finding a convenient means of mounting the capacitor.

The IEC code of practice proposes that single point earthing is the preferred technique, because of the need to avoid ill-defined circulating currents, which may be incendive. It does however permit the

use of small decoupling capacitors to reduce the high frequency problem. There is a special case escape clause which states, 'If the installation is effected in such a manner that there is a high level of assurance that potential equalisation exists between each end of the circuit (i.e. between the hazardous area and the non-hazardous area), then, if desired, cable screens may be connected to earth at both ends of the cable and, if required, at any interposing points'. Unfortunately there is no attempt to quantify what is required and hence this relaxation is capable of being interpreted in ways which are significantly different.

The MTL advice is that the initial installation should be effected by earthing the screens at one point, since this is the most acceptable solution in hazardous areas. In the unlikely event that there are interference problems then if possible they should be remedied by using decoupling capacitors. If this cannot be done then consider if the potential equalising condition is met, if it is then multiple earth the screens

In almost all installations the power supply will be close to the host controller and the screens of both trunks should be bonded to the controller earth. Where the power supply is some distance from the host the non-incendive trunk screen should be bonded at the power supply to the equipotential system and the host trunk screen to the host controller earth.

7.4 Other earths

The risk of static discharges causing ignition in a Zone 2 or Division 2 location on the majority of industrial sites is very low. However bonding metallic enclosures to the local equipotential bonded structure reduces the possibility further and hence is normally carried out. The guidance given in IEC60079-14 is that 'exposed conductive parts need not be separately connected to the equipotential bonding system if they are firmly secured to and are in metallic contact with structural parts or piping which are connected to the equipotential bonding system'. Bonding enclosures is usually advantageous in reducing the effects of interference, may be necessary for personnel safety reasons and the requirement is not onerous and hence is a recommended practice.

The sources of power to a FNICO system are the mains supply to the 24 V supply and the 24V supply itself. The earthing requirements and electrical protection of these supplies should follow the usual pattern, which is normally decided by standard site practices. The galvanic isolation within the MTL power supply ensures that the effect of earth faults in the supply circuits is not transferred to the fieldbus trunks.

8 CABLES AND ACCESSORIES

8.1 Cables

The choice of cables for use with fieldbus signals is not restrictive, and frequently existing cables can be used thus reducing installation costs. Where a 'gas clearance certificate' can be obtained the suitability of an existing cable can be checked by using the combination of the FBT-3 and FBT-5 testers as discussed in section 4. There are a number of cables specifically designed to carry the 31.25 kbit/s signal which usually follow the specification of the cable used in the conformance testing of fieldbus circuits. This is a 'single twisted pair cable meeting the following minimum requirements at 25°C.

- impedance at fr (31.25 kHz) = $100\Omega \pm 20\%$
- maximum attenuation at 1.25 fr (39 kHz) = 3.0 dB/km
- maximum capacitive unbalance to shield = 4nF/km, tested using a 30m or longer sample
- maximum d.c. resistance (per conductor) = $24\Omega/\text{km}$
- maximum propagation delay change 0.25 fr to 1.25 fr = 1.7 us/km
- conductor cross sectional area (wire size) = 0.8 mm^2 (#18 AWG)
- minimum shield coverage shall be 90%

The FNICO technical specification requires that the NI trunk should have the cable parameters as already stated in Table 2. A typical instrument cable has parameters of 50Ω/km, 0.8mH/km and 120nF/km and almost all instrument cables fall within the permitted parameters.

From a safety viewpoint, when the non-incendive fieldbus circuit is adequately screened in a separate cable, then no further segregation from power or signal cables is necessary. However, segregation is normally desirable between fieldbus cables and other heavy current cables to ensure that interference problems are minimised and clear identification of the cables is possible. Non-incendive cables should be clearly identified.

The non-incendive trunk must not be contained in the same multi-core cable as intrinsically safe circuits.

8.2 Terminators

The purpose of the terminator is to present a 100Ω impedance at the end of the trunk so as to match the cable impedance and avoid reflections. The FNICO power supply contains a permanently connected terminator which defines one end of the NI trunk. The field end of the NI trunk also requires to be terminated by a suitable terminator, such as the FBT1-IS. This terminator is certified as Category II 1 in accordance with the ATEX 94/9/EC apparatus directive, and as EEx ia IIC T4 apparatus in accordance with the CENELEC IS standard EN 50020, and is suitable for use in an energy-limited Zone 2 circuit. The terminator has permitted input parameters as required by the FNICO standard and hence can be used in any FNICO circuit without any further consideration of the system safety.

(NOTE: The terminator, because of its wide range of permitted input parameters, is also suitable for use in other fieldbus circuits.)

The terminator is housed in a plastic enclosure, which provides IP20 ingress protection and is intended for DIN rail mounting within an enclosure having adequate protection from the environment in which it is placed. The duplicated NI trunk terminals provide a useful facility for connecting the final spur.

The terminator defines the end of the NI trunk. Care should be taken in choosing its location so as to ensure that the 30m restriction on spur length does not create a significant problem.

8.3 Wiring hubs and enclosures

In almost all circumstances it is usual to connect individual instruments via spurs from the NI trunk, so that a particular instrument can be removed or replaced without interrupting the operation of the whole system. 'Daisy-chain' connections and the use of more than one wire per terminal are not the recommended practice for both serviceability and reliability reasons.

A suitable wiring hub is the Relcom *Megablock*, which uses plug-in terminals to allow the trunk to be connected to individual instruments on spurs. Screws retain the plug-in spur terminals so as to ensure the integrity of the interconnection.

FCS-MBx series Megablocks are available in different versions with 2, 4 or 8 spurs. For example, the basic 4-drop version is FCS-MB4. When designing a system it is desirable to have spare capacity so that any future additions to the system can be made without major modifications or additions to the trunk wiring. An unused spur connection is also a useful point for the connection of any suitably approved test equipment.

Megablocks are also available with built-in electronic spur protection. This facility means that the trunk is protected when an individual spur or spurs are in short-circuit, so that the instruments on unaffected spurs remain active. Megablocks with 'Spurguard™' protection are identified by the -SG suffix, such as FCS-MB4-SG.

The standard and Spurguarded Megablocks carry ATEX Category 3 approval for use in energy-limited Ex n circuits in Zone 2, and Factory Mutual approval to FM3611 for use in non-incendive circuits in Division 2.

8.3.1 FNICO power supply with standard Megablock in IEC Zone 2

For installations in IEC Zone 2, the non-Spurguard Megablock types FCS-MB2, FCS-MB4 and FCS-MB8 are covered by Relcom ATEX Declaration of Conformity ATEX500-047. The Declaration is for ATEX Category 3 apparatus, with certification code II 3 G EEx nAL. Note 9 of the Declaration states that the 'L' suffix applies when the trunk and spurs are energy-limited, which is the case when the Megablock is used with either of the FNICO power supplies. In this instance, the Megablock does not modify the output safety parameters of the FNICO power supply, so that the safety parameters of each spur are the same as those for the power supply itself. For example, when used with the 9111-NI, the safety parameters of each spur on the Megablock are $U_o = 14.0V$, $I_o = 233mA$.

The internal inductance, L_i and capacitance, C_i of the Megablock are negligible, so it complies with the requirements for FNICO apparatus.

8.3.2 FNICO power supply with Spurguard™ Megablock in IEC Zone 2

For installations in IEC Zone 2, the Spurguarded Megablock types FCS-MB2-SG, FCS-MB4-SG and FCS-MB8-SG are covered by Relcom ATEX Declaration of Conformity RELO2ATEX500-086. The Declaration is for ATEX Category 3 apparatus, with certification code II 3 G EEx nAL. Note 9 of the Declaration states that the 'L' suffix applies when the trunk and spurs are energy-limited, which is the case when the Megablock is used with either of the FNICO power supplies. The Spurguard function is capable of making the spurs energy-limited (Ex nL) even when the trunk is non-arcing (Ex nA), but in the case where the Megablock is used with the FNICO power supplies the trunk is already energy-limited.

The Spurguard Megablock modifies the safety parameters of the spurs, as follows:

$$\begin{aligned}U_o &= U_o \text{ of trunk} = 14.0V \text{ (9111-NI) or } 14.8V \text{ (9112-NI)} \\I_o &= 60mA \\L_o &= 1.26mH \\C_o &= 170nF\end{aligned}$$

Although L_o and C_o values are stated, they may be ignored when the cable type and spur lengths comply with the requirements of the FNICO Technical Specification.

8.1.3 FNICO power supply with standard Megablock in Division 2

For installations in Division 2, the non-Spurguard Megablock types FCS-MB2, FCS-MB4 and FCS-MB8 are covered by Factory Mutual approval 3013269. The approval is for Class I, Division 2, Groups A-D T4. The Megablock does not modify the non-incendive field wiring parameters of the FNICO power supply, so that the parameters of each spur are the same as those for the power supply itself.

8.1.4 FNICO power supply with Spurguard™ Megablock in Division 2

FNICO installations in Division 2 that require spur short-circuit protection will be satisfied by the Spurguard Megablocks type FCS-MB2-SG, FCS-MB4-SG and FCS-MB8-SG. Approval by Factory Mutual is pending; contact MTL for further information.

The Megablock provides IP 20 ingress protection. The units are intended for DIN rail mounting within an enclosure which provides adequate protection against the environment in which it is mounted.

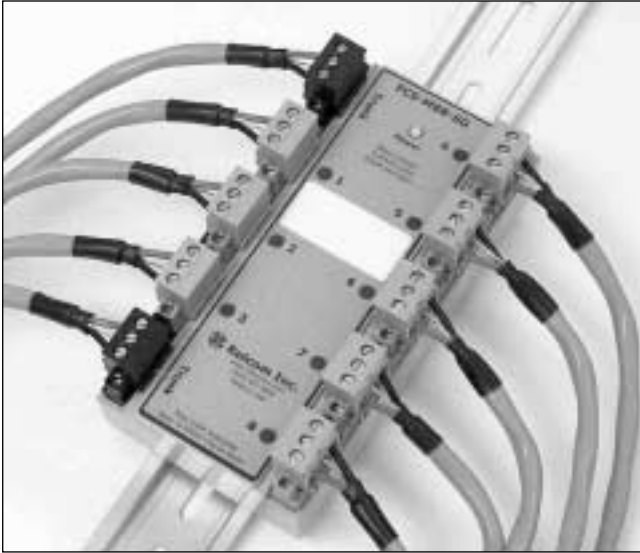

Figure 16 - Megablock FCS-MB8-SG wiring hub

The principal requirement for mounting any energy-limited or associated apparatus is that the method of mounting should not allow the method of protection to be invalidated by any foreseeable contamination, mechanical damage, or unauthorised interference.

Usually the equipment in the safe area is mounted in conventional cabinets and there is no significant problem. In some circumstances, there may be a need to consider the temperature rise within a closely packed cabinet.

Where equipment is mounted in less favourable circumstances, for example in the field; a higher level of protection is required. When the enclosure is mounted in the hazardous area, the enclosure must meet specific requirements.

The enclosure materials should comply with the requirements of IEC 60079-0, which specifies the 'General Requirements' of apparatus used in hazardous areas. For example a plastic enclosure is required to have anti-static properties and some resistance to solar radiation. Although it is not specifically required, the most convenient way to ensure a satisfactory choice of enclosure in countries that follow IEC/CENELEC rules is to use an Exe (increased safety) component approved enclosure. The installation remains an NI installation and the enclosure needs to be clearly identified as containing NI circuits to ensure that maintenance procedures are correctly followed. A Division 2 approved enclosure may be selected in North America. The enclosure should be sufficiently large so that the contents are easily fitted and wiring can be easily connected. The space required for the tidy accommodation of wires is usually underestimated and sharp bends in wires are always undesirable, especially in low temperature environments. Where the enclosure accommodates apparatus with plug in terminals, such as the Relcom Megablocks, extra space is required so that the plugs can readily be removed and to permit the attached cables to flex as the plug is removed. A typical stainless steel field enclosure, containing an 8-way Megablock, is illustrated in Figure 17.

Space should be allowed for glands and their installation. It is desirable to drill holes to accommodate all the glands that will be required when all the spare capacity in the enclosure is utilised. Any temporarily unused gland holes should be closed with blanking plugs, to maintain the IP rating of the enclosure. The number of glands required frequently decides the size of the enclosure.

The choice of glands is decided by the requirement to be compatible with the cable used, to maintain the ingress protection of the enclosure and to comply with the spacing of the gland holes. Frequently, certified Exe glands are used since these are readily available and may be a site standard, but certification is not a requirement.

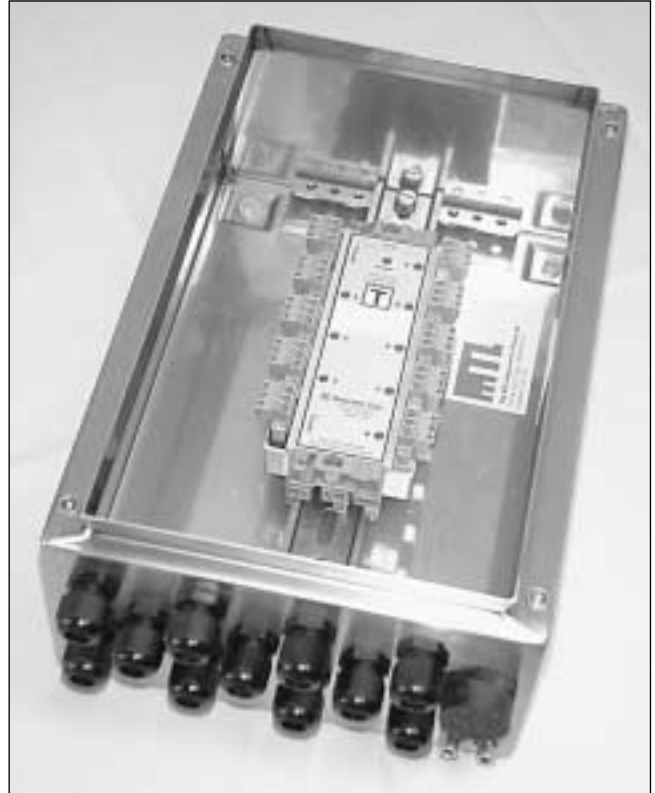

Figure 17 - Termination block inside typical field enclosure

Consideration should be given to fitting breathing/drain devices to reduce the possible problems caused by condensation. Whether such devices are fitted is a decision relevant to a particular installation based on local knowledge, but it should be a conscious decision.

Elevation of the internal temperature of an enclosure is not a problem for enclosures containing only interconnection blocks. Enclosures containing power supplies will have an internal temperature rise, which is a function of the contents and layout of the enclosure. It is difficult to generalise about all the possible combinations, but allowing for an internal temperature rise of 15°C is a reasonable estimate for a metal enclosure, which is not tightly packed. The usual practice of avoiding excessive solar radiation by shading should be followed, and locating the enclosure so that easy access for installation and maintenance purposes is desirable. The maximum permitted ambient temperature of the equipment determines the maximum external operating temperature. A T4 temperature classification is always achieved if the maximum permitted ambient temperature is not exceeded.

9 SURGE PROTECTION

9.1 Introduction

This section discusses the protection of a FNICO system against electrical surges. Despite the increasing robustness of modern designs, damaging surges can come from a number of sources, of which the most common is from adjacent lightning strikes. In assessing the necessity for surge protection, it is important to recognise that fieldbus systems are susceptible to common mode failures that can close down the whole system. It is difficult to summarise the circumstances in which surge suppression becomes necessary but protection of all inputs to the system from external sources and all wiring runs within the system which are longer than 50m horizontal or 10m vertical should be considered. Lightning and surge protection for fieldbus systems is comprehensively discussed in MTL Surge Technologies application note TAN 1010 and this should be consulted for a more complete picture. It is important to recognise that surge damage does not always produce instantaneous failure. The long-term failures (six months) that appear intermittently at inconvenient times are frequently more expensive and always more difficult to find.

The use of surge protection devices (SPDs) on a non-incendive circuit results in the circuit being indirectly 'earthed' at more than one point, which is contrary to the normal practice. However the use of SPDs is an acceptable practice, which improves safety, and is covered by sections in the IS systems standard IEC 60079-25 and the code of practice IEC 60079-14. The MTL Surge Technologies application notes TAN 1004 and TAN 1005 consider the interaction between intrinsic safety and surge protection in more detail.

NOTE: The TANs mentioned in this section, other application notes on surge protection, and relevant data sheets can be obtained on line at www.mtl surge.com or from your local MTL representative.

9.2 Compatible surge protection devices

Where an SPD is used on a non-incendive fieldbus trunk or spur it must not have significant capacitance or resistance. The use of standard SPDs is unlikely to produce acceptable results and may not be safe. The capacitance of the SPD must be low (less than 100pF) so as not to affect the safety analysis of the system or to attenuate the fieldbus. The resistance introduced must also be low (less than 1Ω), since a significant resistance would reduce the useable trunk length. A resistance of a few ohms can also cause an impedance mismatch.

The two devices specifically designed for use on the fieldbus trunk and spurs are:

a) The FP 32 (shown in Figure 18), which is a DIN rail mounted unit and is used as part of the wiring system when an enclosure or other protection against the environment is present. It is a series device and introduces a resistance of 0.5Ω into each lead. This resistance should theoretically be taken into account when deciding the available trunk length of a system (trunk cable loop resistance 50Ω/km), but can usually be ignored. The effective device capacitance is less than 50 pF and can be ignored from both an operational and safety viewpoint. The FP32 has provision for terminating and protecting the cable screen.

The FP 32 contains no active components, and is 'simple apparatus' in accordance with clause 5.4 of EN 50020:2002 (see Section 13). The device can therefore be inserted into a non-incendive system without modifying the safety analysis. When used in a Zone 2 type 'n' circuit the FP32 acquires the type of protection of the circuit in which it is used, that is type 'nA' in a non-arcing circuit and type 'nL' in an energy-limited circuit.

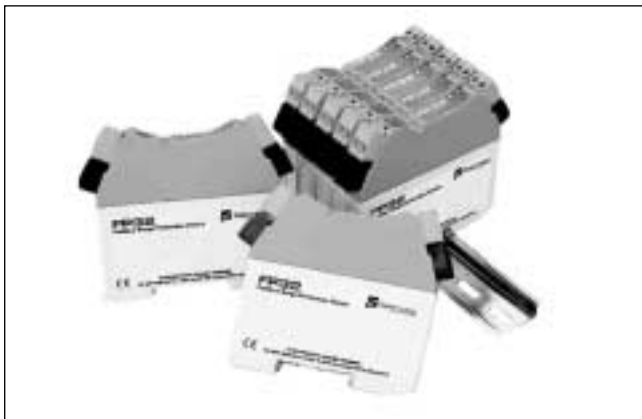

Figure 18 - FP32 Surge Protection Devices

b) The TP 32 (shown in Figure 19), which is mounted in a hexagonal stainless steel enclosure and is designed to be screwed into an unused port of a field mounted device. It is a parallel device and introduces no series resistance into the trunk or spur. Its effective capacitance is less than 50pF and hence is negligible.



Figure 19 - TP32 Surge Protection Devices

The TP32 device is certified EEx ia IIC T4 to the CENELEC IS apparatus standard EN 50020 and meets the requirements of Category 1 equipment in accordance with the 94/9/EC (ATEX) Directive. Because it has negligible inductance and capacitance, this device can also be introduced into a non-incendive system without modifying the safety analysis. When used in a Zone 2 type 'n' circuit the device is either 'nL' or 'nA' as decided by the circuit in which it is used.

c) The MA4000 (shown in Figure 20), which is the power supply SPD normally used with fieldbus applications. It is a parallel device that is easy to mount and has the additional advantage of meeting the requirements for Zone 2 or Division 2 mounting.

Full details of these devices are available on their respective data sheets.



Figure 20 - MA4000 Surge Protection Devices

9.3 Protecting the system

No two fieldbus installations will be the same, but the surge protection of any system can be considered by analysing the separate sections as illustrated by the simple system of Figure 21. A systematic progression through the possible sources of problems, and deciding what precautions (if any) are necessary is a desirable approach.

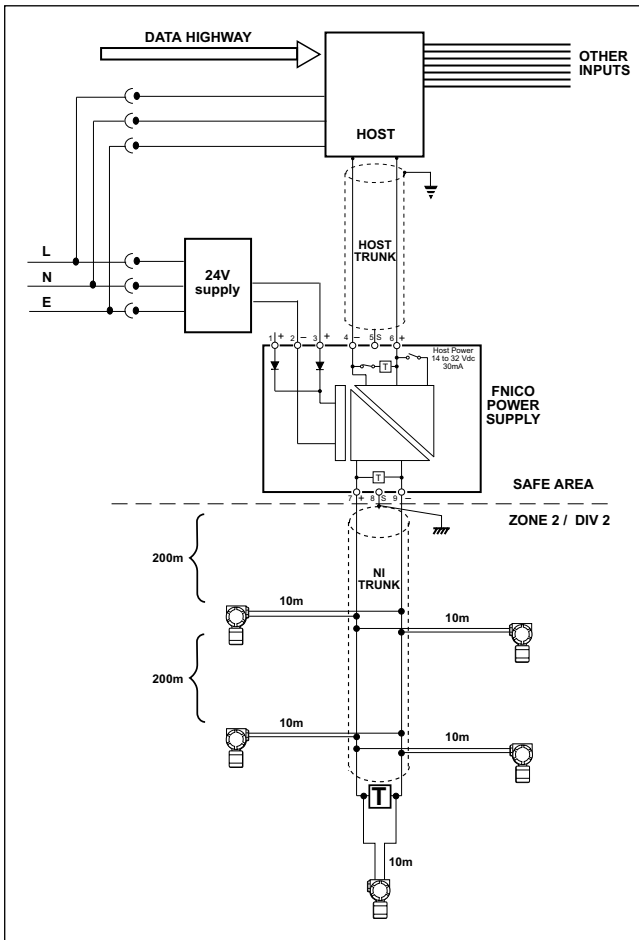

Figure 21 - Typical fieldbus system

9.3.1 Host

The host has to be checked to ensure that it is protected from invasion via all its input connections because surges can cause significant damage beyond the immediate interconnecting interface.

The mains supply input is frequently subjected to surges either from adjacent lightning strikes or switching surges from other equipment connected to the system. Unless the supply is already part of a carefully protected supply, the use of a dedicated SPD is recommended. If the FNICO power supply is close then sharing the protected supply is a practical proposition. The MA4000 is normally used as the dedicated protector.

The communications highway above the host controller normally requires protection, because it is quite frequently long and may even cross into equipment powered from a different distribution centre. The type of SPD required varies with the form of the data being transmitted.

The other data inputs should all be examined to establish whether they should be protected. Similarly connections to peripheral equipment should be examined even though they are unlikely to be a source of problems.

The host trunk is not likely to require protection if the FNICO power supply is close to the host, which is the usual situation when the two devices are in the safe area. If the FNICO power supply is moved away from the host, or if the host trunk is connected to other fieldbus elements in the field then the host trunk terminals may need protection. The FP32 is the preferred SPD for this purpose.

The 'earthing' or bonding of the SPDs associated with the host requires some care so as to maximise the effectiveness of the protection. Advice on the best techniques is given in TAN 1003.

9.3.2 24V supply

The mains supply to the 24V supply requires the same consideration as that of the host. If the supply is moved away from the host, and supplied from a field ring main, it will almost certainly require to be separately protected. The MA4000 is the usual solution.

Normally the 24V supply and the FNICO power supply are mounted close together so as to avoid having significant voltage drop between the two devices and hence surge protection is not necessary. If the 24V supply is carried a significant distance and/or used to supply significant power to other apparatus then surge protection may be necessary.

9.3.3 FNICO power supply

The host trunk connection only requires protection at the FNICO power supply end in the unusual situation where the trunk connection to the host also requires protection. It is almost always the case that a cable needs to be protected at both ends since protecting one end invariably increases the problem at the other. The process is therefore to decide whether the trunk connection at the host needs protection. If it does then the connection at the FNICO power supply also needs to be protected. The FP 32 is the preferred solution.

The non-incendive trunk connection normally needs protection if it is more than 100m long in the horizontal direction (even 50m should give pause for thought) or 10m in the vertical direction. This means that almost all installations need to be protected. The non-incendive trunk illustrated in Figure 21 would require to be protected in almost any location in the world. The FP32 is the preferred solution.

9.3.4 Field devices

Where the field devices are spurred off from the end of the trunk on short spurs as illustrated in Figure 21, then they can all be protected by a single SPD at the point where the end of the NI trunk enters the junction box. The FP32 mounted in the junction box provides a solution. The FNICO system rules only allow spurs of up to 30m in length, and hence long spurs are not a reality. However if a 30m spur was taken vertically up a vulnerable structure then a considerable voltage could develop between the field device and the junction box. The ideal solution is to relocate the junction box so as to avoid the problem. Where this is not possible, it is better to forget the common protection of the field devices and protect them individually. A TP32 protecting each of the three devices becomes the preferred solution. The two possibilities are shown in Figure 22.

The two devices located midway on the non-incendive trunk are vulnerable to surges from both directions and the simplest solution is to abandon the possibility of common protection, and to individually protect the field devices using a TP 32.

The SPDs associated with field devices are usually bonded to the adjacent plant structure, which is part of the equipotential plane of the plant. This prevents local potential differences, which is the principal cause of damage and provides a path for the surge current.

9.3.5 Connecting blocks and terminators

The IS terminator type FBT1-IS is constructed so that it will withstand a high level of common mode surge voltage pulses and a 600V series mode pulse.

When used in conjunction with field devices protected as described in the section above the connecting block and terminator are directly protected by the shared FP32 or indirectly protected by the surge protection of the TP32s on the field devices. The number of TP32s and their relative positions with respect to the junction box affects the protection offered by the TP32. However the residual surge should not damage the Megablock or terminator.

Figure 22 illustrates comprehensive surge protection of the system shown in Figure 21. It does not address the less frequently required protection of the host bus or the separate protection of the mains supply to the 24V supply, since these are straightforward modifications. The alternative techniques for protecting the three field devices at the end of the field trunk are illustrated.

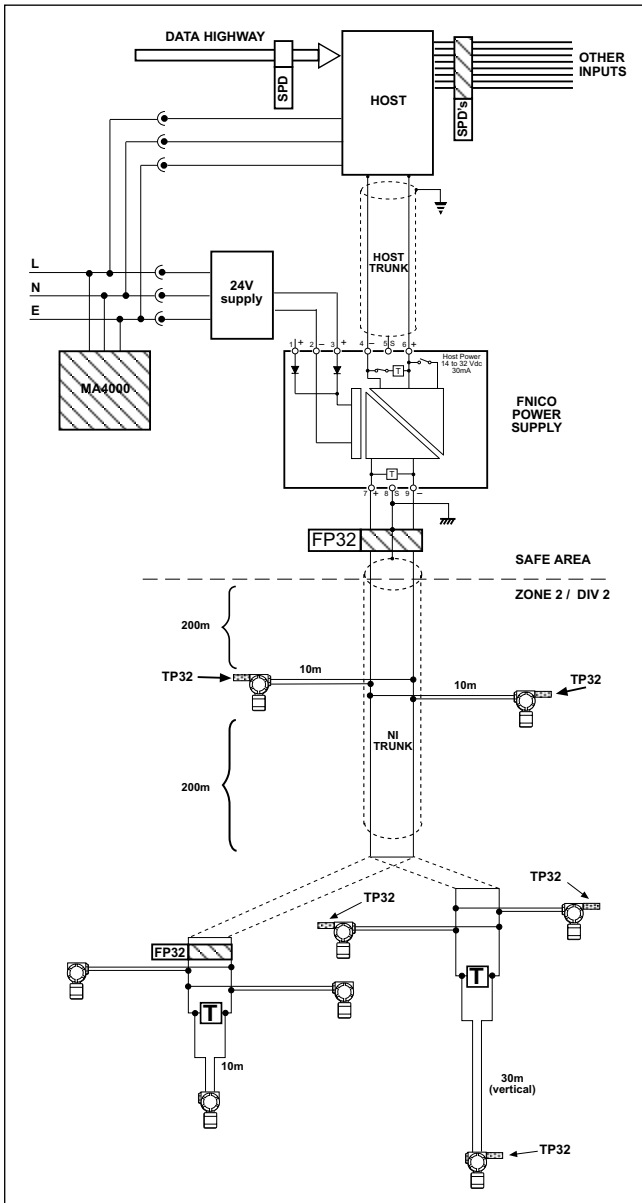

Figure 22 - Adequately protected fieldbus system

10 MOUNTING OF FNICO POWER SUPPLIES IN ZONE 2 AND DIVISION 2

10.1 General

The 9111-NI and 9112-NI power supplies are approved for installation inside a Zone 2 or Division 2 hazardous area. This facility may be desirable in some circumstances, for example where the power supply is used as a repeater to extend the length of the trunk.

10.2 Typical installation

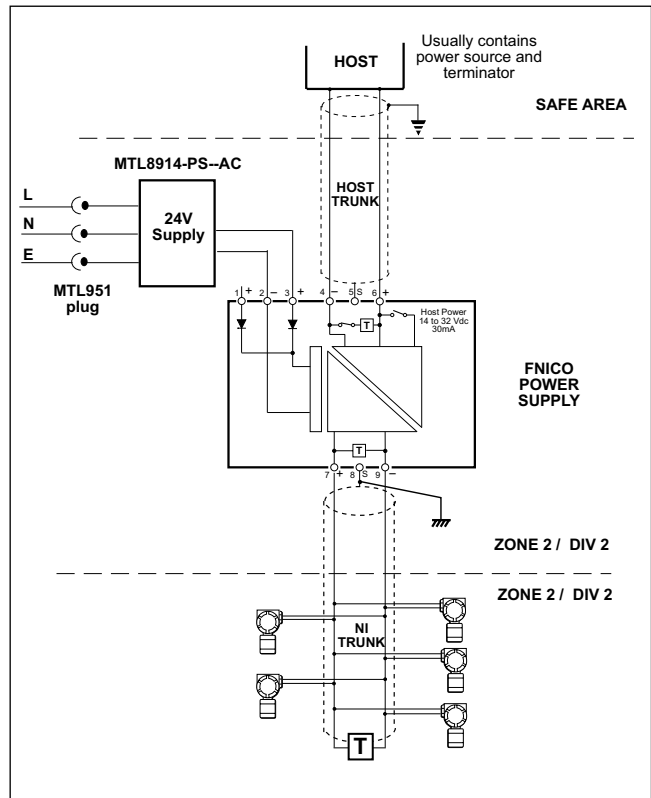

Figure 23 - FNICO power supply installed in Zone 2 or Division 2

Figure 23 illustrates the simplest installation of the power supply in a Zone 2 or Division 2 location. A host controller is connected to the non-hazardous side of the power supply. Where the host controller supplies power to the bus and contains a terminator, the FNICO power supply does not have its terminator switched in and has its internal host power supply disabled. When used in this mode, terminals 4 and 6 only draw a very small current (less than 4mA) and generate a signal current of $\pm 10\text{mA}$. In consequence the length of the host trunk is determined entirely by operational considerations and can be a maximum of 1.9km for a type A cable.

10.2.1 Host trunk wiring

The host trunk itself is usually non-arcing because the host controller is unlikely to have non-incendive approval. Hence the cable must be mechanically protected from damage. The screened cable normally used for fieldbus trunks satisfies the requirements of non-arcing installations. It is not usual to provide an elaborate means of isolation or fusing for these low power cables because even under fault conditions the cable is not likely to suffer overheating. Terminal blocks with knife-edge disconnects or a plug and socket in the safe area are considered to be adequate. Although the cable is non-arcing, the plug which contains terminals 4 and 6 can in practice be disconnected without isolating the circuit because in normal operation the level of current flowing in the host trunk is incapable of ignition. However, it should be noted that although the spark created by disconnecting this plug is non-incendive, shorting the host trunk may create an incendive spark. (The plug is constructed so that it is not easily short-circuited when it is disconnected). It is therefore not permissible to risk shorting the host trunk wiring without first disconnecting the trunk in the safe area or isolating the supply.

10.2.2 24V power supply

The FNICO power supply requires a 24V supply, which can be derived from any convenient source. The isolation between the source of this power and the two fieldbus trunks removes any concern about interaction between the fieldbus system and other equipment connected to the 24V supply. Figure 22 shows the 24V supply being derived from MTL's 8914-PS-AC power supply, which is approved for mounting in Zone 2 and Division 2 locations. The power supply out-

put is rated at 10A, so the interconnecting wiring (which would normally be within the same enclosure) is non-arcing, and is required to be secure. If this wiring is rated at 10A, the current limit in the power supply is adequate protection against overheating. Shorting the wiring from the 24V supply would create an incendive spark; it is therefore not permissible to risk shorting the interconnecting wiring without first isolating the supply.

The supply current drawn by the FNICO power supplies could exceed the minimum ignition current for their respective gas groups, so the plug carrying the 24V supply may not be removed from the unit while energised.

The mains supply can be derived from any convenient source, but must comply with Zone 2/Division 2 non-arcing requirements. If the ability to isolate the system locally is required, then the use of an MTL 951 flameproof plug, as shown in Figure 24 is a convenient technique. This also facilitates the replacement of the power supply, should this prove necessary.



Figure 24 - MTL951 EEx d plug and socket

10.2.3 Non-incendive trunk

The installation of the non-incendive fieldbus trunk follows the usual requirements of such systems. The isolation from the 24V supply and the host trunk provided by the FNICO power supply removes any necessity to consider interaction between the non-incendive trunk and the other circuits.

The screens of the buses are usually earthed or bonded at one end as illustrated in Figure 21. The host trunk screen is normally earthed at the host to the clean earth busbar. The NI trunk screen is normally bonded at the FNICO power supply to the structure or equipotential system via the enclosure bonding connection.

10.3 Environmental considerations

The fundamental requirement of mounting these units in Zone 2 or Division 2 is that they should be adequately protected from environmental effects, which can adversely affect their safety. Among the effects normally considered are protection from weather, contamination by dust or corrosive atmospheres, ambient temperature, solar radiation, mechanical impact and unauthorised interference. There is no universal solution applicable to all locations which is economic and practical, but there are some general guidelines which may prove helpful.

If the location is outdoors in a normal industrial location then the requirement is an enclosure which has a minimum ingress protection rating of IP54, an impact rating of at least 7Nm, and adequate resistance to corrosion. The usual solution is to use an Exn or Exe or Division 2 approved enclosure since this provides some assurance of suitability, and avoids having to be concerned about the effects of static and provision for bonding etc. If a reasonable size enclosure is chosen (frequently determined by the necessity to make provision for adequate glanding and making off of the field cables) then a tem-

perature rise within the enclosure of less than 15°C can be expected. With the equipment under consideration then the temperature limitation under consideration is the ambient temperature limit of 70°C. This restricts the external ambient temperature of the box to 55°C, which is adequate for most locations provided that direct sunlight is avoided. The temperature rise inside the enclosure is not an entirely negative feature, since it does tend to prevent condensation while the equipment is turned on.

There are situations where these levels of ingress protection are not adequate, and the installer should be aware of these. For example in the offshore industry it is usual to specify enclosures which will withstand the deluge test. There are also installations where these levels of protection are not necessary, for example in some locations in the pharmaceutical industry there are Zone 2 or Division 2 areas that are clean and dry with restricted access and a standard 19-inch rack would be adequate. The decisive question is, "is the enclosure 'adequate for the purpose'?", and there is no single answer that fits all locations.

Temperature classification of this Zone 2/Division 2 installation is not a problem and would possibly justify a T6 (85°C) classification. However since almost all applications only require a T4 (135°C) classification the temperature classification is restricted to T4 at 70°C ambient since this is beyond any possible dispute.

10.4 Maintenance and fault finding

One of the disadvantages of non-arcing circuits is that usually working on the circuits without first isolating the circuit is not permitted. The alternative is to operate under a 'gas free clearance' certificate system (which is usually available in most hazardous locations) when the practices used in safe areas are acceptable.

In the particular case of the MTL FNICO power supply the plug-in terminals carrying the host trunk can be disconnected without first isolating the supply, because the current normally carried is non-incendive and the risk of shorting the leads together is low. This facility used with the status LEDs on the FNICO power supply enables almost all of the diagnostic process to be carried out, before the circuit must be isolated. The non-incendive trunk may of course be live-worked without gas clearance.

Note: The terminal plugs can be withdrawn, but the leads should not be removed from the terminals without first isolating the system.

10.5 Further combinations

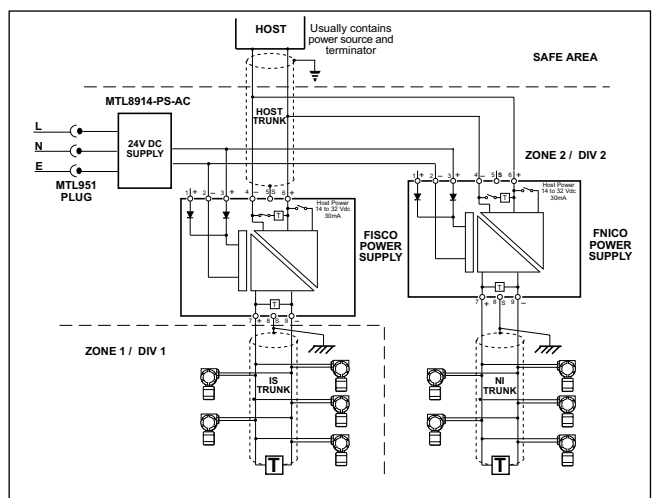

Figure 25 - Additional fieldbus power supply connected

The host bus can be used to interconnect other fieldbus devices and systems. Theoretically up to 31 devices can be connected to the host bus. In practice the number is restricted by the capability of the port on the host controller and is normally restricted to 16.

The FNICO power supply transfers the field device signals from the non-incendive bus to the host bus; consequently, it is the total number of devices connected, directly or indirectly, to the port which is relevant.

Figure 25 illustrates the possible interconnection of a second power supply to the host bus. This power supply could be a FISCO power supply or another type of supply suitable for mounting in Zone 2 or Division 2 and providing power to Zone 2 or Division 2 field devices. In addition, any suitably approved field device can be connected to the host bus provided that the usual operational requirements are satisfied.

The second fieldbus power supply can share the 24V power supply and be housed in the same enclosure. As the FNICO and FISCO power supplies require only a very small continuous current, the length of the host bus is determined only by operational considerations. The total number of field devices connected to both power supplies must not exceed the capability of the host port. Only one of the two terminators available at the end of the host bus should be switched into the circuit.

11 CERTIFICATION AND SAFETY DOCUMENTATION OF FNICO SYSTEMS

11.1 Introduction

This section reviews the certification of the MTL FNICO power supplies in detail and the certification required of other components of the system. In common with FISCO, a major simplification embodied in the FNICO technical specification is the simplification of the required documentation. A hypothetical system is used here to illustrate the relative simplicity of creating the required documentation.

The CE mark (which appears on all MTL products) indicates that the product conforms to all the relevant European Community (EC) directives, not just the ATEX directive.

Copies of all MTL certificates and Category 3 documents of conformity can be obtained from MTL. Many end-users prefer to store copies of apparatus certificates in some form, but it is desirable to eliminate the storing of paper copies and to obtain a current copy of the certificate electronically from the manufacturer when and if it is needed.

11.2 MTL FNICO power supplies

11.2.1 Factory Mutual approval

The 9111-NI and 9112-NI are approved by Factory Mutual Approvals Corp. to standard No. 3611 ('non-incendive'), under project ID. 3016981. The approval covers installation of either unit in Class I, Division 2, Groups A - D and Class I, Zone 2, Group IIC hazardous locations.

The field wiring of the 9111-NI is approved as non-incendive for connection to Class I, II, III, Division 2, Groups A-G and Class I, Group IIC hazardous locations, with Non-Incendive Field Wire parameters $V_{oc} = 14.0V$, $I_{sc} = 233mA$.

The field wiring of the 9112-NI is approved as non-incendive for connection to Class I, II, III, Division 2, Groups C-G and Class I, Zone 2, Group IIB hazardous locations, with Non-Incendive Field Wire parameters $V_{oc} = 14.8V$, $I_{sc} = 380mA$.

Rules governing installation of the power supplies and connections to field devices are described in MTL Control Drawing SCI-975, which accompanies the approval. This drawing is reproduced in Appendix IV.

11.2.2 ATEX Category 3 approval

ATEX Category 3 certification is covered by MTL 'declarations of conformity' MTL03ATEX9111X and MTL03ATEX9112X. These declarations justify the mounting of the FNICO power supplies in Zone 2, and connection of the field wiring into Zone 2. They classify the apparatus as II 3 GD, which translates as Category 3 apparatus (normally used in Zone 2) for use in surface industries in both gas and dust atmospheres.

The 9111-NI has the marking EEx nA[L] IIC T4 ($-40^{\circ}C \leq T_a \leq +60^{\circ}C$), which relates to the CENELEC certification to the EN50021: 1999 EEx n standard. The 'A' applies to the non-arcing construction of the power supply and the nature of the 24V supply and host trunk connections. The 'L' and 'IIC' apply to the energy-limited field trunk. The T4 temperature classification corresponds to a maximum surface temperature of $135^{\circ}C$ at the maximum ambient temperature of $+60^{\circ}C$. This makes it suitable for use in all gases except carbon disulphide.

The letter 'X' at the end of the certificate number indicates that its safe use depends on special conditions being met. In this case, the conditions require that the power supply be installed in an enclosure appropriate to the gas or dust environment and that it be protected from large supply transients.

The 9112-NI power supply is certified in the same way as its companion power supply except that it is certified for gas group IIB (ethylene) which allows a greater output power, but excludes its use in association with IIC gases, which comprise hydrogen, acetylene and carbon disulphide.

Where a FNICO power supply is used in association with dust atmospheres, the 9112-NI supply should normally be used, since it provides additional power, but is still acceptably safe.

11.3 MTL terminator

The IS certification of the MTL fieldbus terminator type FBT1-IS is covered by an EC-type examination certificate issued by Baseefa (2001) Ltd. The certificate number is Baseefa02ATEX0042 and requires that the apparatus be marked Ex II 1 G EEx ia IIC T4 ($-40^{\circ}C \leq T_a \leq +70^{\circ}C$). Although the terminator is designed for use in an intrinsically safe fieldbus circuit, its certification and construction exceed what is required for inclusion in an energy-limited Zone 2/Division 2 circuit. The terminator meets the requirements of Clause 5 of the FNICO technical specification.

11.4 MTL 24V Zone 2/Division 2 power supply

The 8914-PS-AC power supply is certified as Category II 3 G in accordance with EN50021: 1999 and designated EEx nA II T4 by TÜV under certificate number TÜV01ATEX1774X. It is also certified by Factory Mutual Research Co. (FM) as Class No. 3600/3611 for use in Class I, Division 2, Groups ABCD hazardous locations.

11.5 Cables

Cables are not required to be certified by the ATEX directive or by the IEC/CENELEC code of practice. They should comply with the requirements of the FNICO technical specification. The majority of instrument cables fall well within the specified limits. Satisfactory evidence of compliance may be obtained from the cable manufacturer, or by testing a sample (at least 10m long) with a bridge using a frequency of 10kHz.

11.6 Interconnection blocks

The Relcom Megablocks FCS-MBx and FCS-MBx-SG are approved by Factory Mutual for installation in Division 2 hazardous areas, and are covered by ATEX Category 3 Declarations of Conformity for use in Zone 2. Refer to Section 8.3 for more details.

11.7 Enclosures and glands

Enclosures and glands do not need to be certified when used to protect Ex n apparatus. The requirement is to be 'adequate for the purpose', which is to protect the apparatus from contamination, mechanical damage and unauthorised interference. Frequently, Ex e component certified enclosures and glands are used so as to ensure adequate protection. However this is not a requirement.

11.8 Simple apparatus

The requirements of simple apparatus and its position under the ATEX Directive are discussed in Appendix I. In the particular case of FNICO systems, the total capacitance and inductance in the apparatus should not be greater than 5nF and 10µH separately.

11.9 Safety documentation

One of the merits of the FNICO system is the reduction of the safety documentation required. Because there is no necessity to carry out the compatibility tests and calculate the permitted cable parameters of the system in the same way as an entity concept system, the documentation can be reduced to a single table.

This is best illustrated by Figure 26, which shows a 'typical installation'.

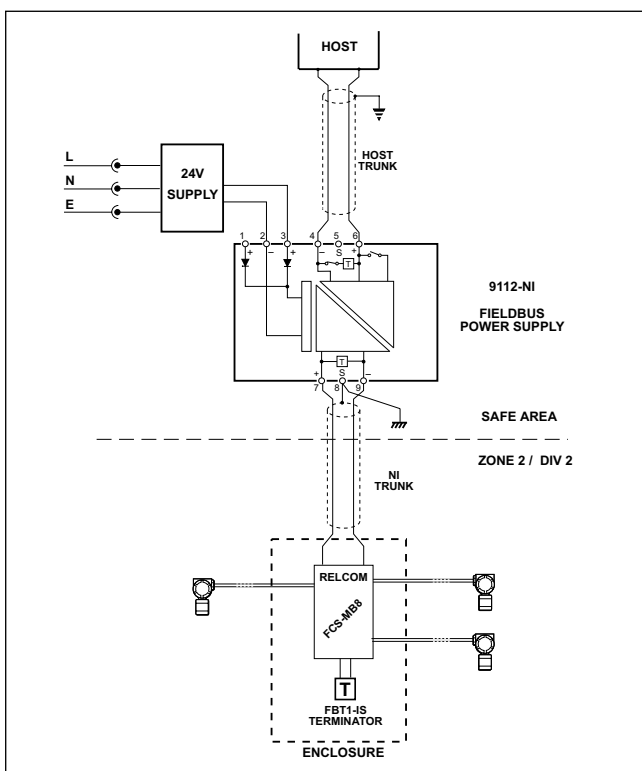

Figure 26 - Typical installation

11.10 Documenting the safety of a FNICO installation

The rules for describing the safety of a FNICO system closely follow those for FISCO. In line with FISCO, there is no need to calculate maximum permitted cable lengths, provided the cable complies with Table 2.

In simple terms the steps are as follows:

1. Confirm that the cable conforms to the FISCO/FNICO requirement.
2. Check that all field instruments carry an intrinsic safety, EEx nL or non-incendive approval.
3. Check that field wiring components and terminators carry suitable approval or are 'simple apparatus'.
4. If the field instruments are not FISCO or FNICO certified, check that the maximum safety input voltage, U_i of each instrument is greater than the output safety voltage, U_o of the FNICO power supply.
5. List the components included in each trunk, noting manufacturer, model number, method of protection, ambient temperature and Temperature Classification.

Although the concept of 'simple apparatus' is not recognised in the CENELEC standard EN50021 or Code of Practice for Zone 2, the principle of non-energy storing apparatus can be applied to non-incendive systems in the same way as for intrinsic safety. Items such as passive wiring components and enclosures do not contribute energy to the non-incendive circuit and may therefore be included without modifying the safety analysis.

For North American Division 2 installations, simple apparatus is recognised in of ANSI/NFPA 70:1999 for use in Nonincendive circuits.

The table in Section 11.11 is an example of the documentation for a typical FNICO system, such as that shown in Figure 26. The documentation would normally be signed and dated by the person preparing the document and checked, signed and dated by a second person. Both signatories would be required to be trained and competent in this particular area of expertise.

11.11 Safety documentation for a FNICO system

System title: Typical Installation (refer to Figure 26)

Conclusion

This safety document demonstrates that the FNICO system described satisfies the requirements of a IIB non-incendive system in which the field devices mounted in the hazardous area all have a T4 temperature classification and can be used in the ambient temperature range of -30°C to $+60^{\circ}\text{C}$.

The cable used for the non-incendive trunk and spurs is UNITRONIC BUS PA blue, type 2020234 T and has parameters compatible with the FISCO/FNICO requirements, and has a useable temperature range of -30°C to $+60^{\circ}\text{C}$.

Item number	1	2	3	4	5	6	7
Description	Power supply	Wiring termination unit	Terminator	Field Enclosure	Temperature Transmitter	Pressure Transmitter	Flow Transmitter
Manufacturer	MTL	Relcom	MTL	Boxco	Tempex Industries	Force Instruments Co.	Surf
Model No.	9112-NI	FCS-MB8	FBT1-IS	JB-18	THC22	BAR-976	Wizwirl 323e
FISCO/FNICO	FNICO	-	FISCO	-	FISCO	-	-
Approval	EEx nA [L]	EEx nAL	EEx ia	Simple Apparatus	EEx ia	EEx ia	EEx nL
Gas Group	IIB	IIC	IIC		IIC	IIC	IIC
Temperature Classification	N/A *	T4	T4	-	T4	T4	T4
Certificate number	MTL03 ATEX9112X	RELO2ATEX 500-047	Baseefa02 ATEX0042	-	XXX02ATEX 0001	YYYO1ATEX 0002	ZZZO1ATEX 0003
Temperature range	-40°C to $+60^{\circ}\text{C}$	-45°C to $+70^{\circ}\text{C}$	-40°C to $+70^{\circ}\text{C}$	-45°C to $+85^{\circ}\text{C}$	-40°C to $+85^{\circ}\text{C}$	-40°C to $+80^{\circ}\text{C}$	-40°C to $+80^{\circ}\text{C}$
Safety voltage (where applicable)	Uo=14.8V	-	-	-	-	Ui=24V	Ui=32V

* Normally T4 but, in this example, the unit is mounted in the safe area

12 APPENDIX I : SIMPLE APPARATUS AND THE ATEX DIRECTIVE

12.1 Introduction

Simple apparatus has been in use as a valuable part of intrinsically safe systems for at least forty years, and the use of this apparatus has to be reassessed with the introduction of the two ATEX directives. The situation was explored in November 2000 at a meeting of the CENELEC sub-committee SC31-3 and the relevant technical advisor to the Brussels Directorate (Noel O'Riordan) and a statement which amplified the guidance given to the same committee in October 1999 was agreed. These two statements remain the accepted interpretation of the directive.

The original guidance was:

"Simple apparatus" will use the phrase from the directive "is not capable of causing an explosion through its own potential source of ignition" thus indicating but not stating that certification to the ATEX Directive is not required. That simple apparatus need not be marked in accordance with Clause 27 of EN 50014: 1997 will be stated."

The final agreed interpretation was:

"Simple apparatus is considered not to require certification by a notified body. The responsibility for compliance with the relevant parts of the standard rests with the persons claiming compliance, who may be a manufacturer or user. Certification to the ATEX Directive is not required because of the low levels of energy, which are added to the intrinsically safe circuit by this apparatus. Simple apparatus is required to be clearly identified when it is installed.

The intention is that simple apparatus is confined to pieces of apparatus which are fundamentally simple. Their safety should be readily verifiable by visual inspection and reference to available data by a competent engineer.

Where a manufacturer considers that certification by a notified body is desirable then this is permitted. In these circumstances, the apparatus shall be certified in the same manner as more complex apparatus in accordance with EN 50020 and the ESRs of the ATEX Directive and be marked accordingly."

The intention of these two statements has been carried through into the apparatus and system standards, and are the accepted interpretation of the ATEX directive on this subject.

12.2 Standards

The most recent apparatus standard is the CENELEC standard EN50020: 2002, which details the requirements of simple apparatus in clause 5.4. This clause is reproduced in full in Appendix II but the complete standard needs to be consulted for comprehensive understanding because of the numerous cross references. The only difference from the IEC requirement in IEC60079-11 is that the clause requiring compliance with the Category 1 standards has been added.

At this time (July 03) the next edition of the IEC/ CENELEC system standard IEC 60079-25 has been given a positive vote and is moving through the editorial process toward publication later in the year. The system standard is not directly relevant to the ATEX apparatus directive, but is utilised when producing documentation for the risk analysis required by the user directive. The system standard does not make any specific reference to the inclusion of simple apparatus but it is necessary to include the known inductive and capacitive parameters (as indicated in clause 5.4b) of EN 50020) in the assessment of the system. In the specific case of a FISCO system, the simple apparatus should have an inductance not greater than 10µH and a capacitance not greater than 5nF, and can then be regarded in the same way as any field device. The 1.5V, 100mA and 25mW limitation is normally considered to apply to the total capability of all the simple apparatus within a single system. Apparatus conforming to

these limitations can be added to an intrinsically safe system without the necessity to reconfirm the safety analysis of the system. The system standard does confirm the requirement to clearly identify the simple apparatus and suggests that the minimum requirement is 'a traceable plant identification label'

12.3 Conclusion

The continued use of simple apparatus in intrinsically safe circuits is compatible with both ATEX directives and the relevant Brussels's directorate has confirmed this. The accepted current practice remains unchanged

Note: The USA still uses the older definition of simple apparatus with the '1.2V, 100mA, 25mW and 20µ' limitations. This makes very little practical difference but has to be taken into account if a system is being designed for world-wide use.

13 APPENDIX II : EXTRACT FROM BS EN 50020: 2002

“ 5.4 Simple apparatus

The following apparatus shall be considered to be simple apparatus:

- a) passive components, for example switches, junction boxes, resistors and simple semiconductor devices
- b) sources of stored energy with well-defined parameters, for example capacitors or inductors, whose values shall be considered when determining the overall safety of the system;
- c) sources of generated energy, for example thermocouples and photocells, which do not generate more than 1,5V, 100mA and 25mW. Any inductance or capacitance present in these sources of energy shall be considered as in b).

Simple apparatus shall conform to all relevant requirements of this standard but is not considered to contain a potential source of ignition capable of causing an explosion and need not be marked in accordance with clause 12. In particular, the following aspects shall always be considered:

- a) simple apparatus shall not achieve safety by the inclusion of voltage and/or current-limiting and/or suppression devices;
- b) simple apparatus shall not contain any means of increasing the available voltage or current, for example circuits for the generation of ancillary power supplies;
- c) where it is necessary that the simple apparatus maintains the integrity of the isolation from earth of the intrinsically safe circuit, it shall be capable of withstanding the test voltage to earth in accordance with 6.4.12. Its terminals shall conform to 6.3.1;
- d) non-metallic enclosures and enclosures containing light metals when located in the hazardous area shall conform to 7.3 and 8.1 of EN 50014;
- e) when simple apparatus is located in the hazardous area, it shall be temperature classified. When used in an intrinsically safe circuit within their normal rating and at a maximum ambient temperature of 40°C, switches, plugs, sockets and terminals can be allocated a T6 temperature classification for Group II applications. Other types of simple apparatus shall be temperature classified in accordance with clauses 4 and 6 of this standard;
- f) where simple apparatus is to be located such that Category 1 G or M1 equipment is normally required, then the apparatus shall also comply with the additional requirements of EN 50284 or EN 50303 as applicable.

Where simple apparatus forms a part of an apparatus containing other electrical circuits, then the combination of apparatus shall be considered as a whole.

NOTE Sensors, which utilise catalytic reaction or other electro-chemical mechanisms, are not normally simple apparatus. Specialist advice on their application should be sought.”

MTL Technical Specification

ELECTRICAL APPARATUS FOR EXPLOSIVE GAS ATMOSPHERES - Fieldbus non-incendive concept (FNICO)

1 Scope

This technical specification, contains the details of apparatus, systems and installation practice for use with the Fieldbus non-incendive concept (FNICO) and is based on the concepts of Manchester encoded, bus powered systems designed in accordance with IEC 61158-2 which is the physical layer standard for Fieldbus installations. IEC 60079-15 and IEC 60079-14 determine the constructional and installation requirements of FNICO apparatus and systems, except as modified by this specification.

Certification to the FNICO requirements does not prevent apparatus also being certified and marked to IEC 60079-15 in the conventional manner so that they may be used in other systems.

A typical FNICO system is illustrated in Figure 1.

This document uses the term non-incendive, to describe apparatus, which is defined as 'energy limited' in IEC 60079-15, and is the low power technique described in the North American non-incendive standards. A simplified explanation of non-incendive circuits is that they follow the concepts of intrinsically safe systems, including permitting live maintenance and assuming field cable faults, but the safety analysis of the apparatus only considers normal operation.

2 Normative references

The following referenced documents are indispensable for the application of this document. For dated references, only the edition cited applies. For undated references, the latest edition of the referenced document (including any amendments) applies

IEC 60079-11, Electrical apparatus for explosive gas atmospheres - Part 11: Intrinsic safety , 'i'

IEC 60079-14, Electrical apparatus for explosive gas atmospheres - Part 14 : Electrical installations in hazardous areas (other than mines)

IEC 60079-15, Electrical apparatus for explosive gas atmospheres - Part 15 : Type of protection 'n'

IEC 60079-27, Electrical apparatus for explosive gas atmospheres - Part 27: Fieldbus intrinsically safe concept (FISCO)

IEC 61158-2, Fieldbus standard for use in industrial control systems - Part 2: Physical Layer specification and service definition

3 Power supplies

The power supply shall either be resistive limited or have a trapezoidal or rectangular output characteristic. The maximum output voltage, U_o , shall be not greater than 17.5 V or less than 14 V.

The maximum output current I_o for any type of power supply shall be determined in accordance with IEC 60079-15 but shall not exceed 518 mA. For rectangular supplies, the following table may be used for assessment.

Table 1 - Assessment of maximum output current for use with rectangular supplies

U_o V	Permissible current, for II C (includes 0,9 safety factor) mA	Permissible current, for II B (includes 0,9 safety factor) mA
14	247	513
15	179	478
16	139	389
17	109	324
17.5	101	287

The maximum unprotected residual capacitance C_i and inductance L_i shall be not greater than 5 nF and 10 μ H, respectively.

The non-incendive output from the power supply may be connected to earth.

The apparatus certificate shall state that the power supply is suitable for use in a FNICO system.

No specification of the residual parameters L_i and C_i or the maximum external parameters L_o and C_o is required on the certificate or label.

4 Field devices

These requirements apply to apparatus other than the power supply and terminators connected to the non-incendive bus whether installed inside or outside the hazardous area. Field devices not intended to be installed within the hazardous area are not required to be temperature classified.

The requirements are as follows:

- a) apparatus shall have a minimum input parameter of U_i : 17.5 V.
- b) under normal conditions as specified in IEC 60079-15 the bus terminals shall remain passive, i.e. the terminals shall not be a source of energy to the system except for a leakage current not greater than 50 μ A;
- c) the bus terminals shall be isolated from earth in accordance with IEC 60079-15;
- d) the bus terminals of separately powered field devices shall be galvanically isolated so as to ensure that these terminals remain passive and multiple earthing of the bus is avoided;
- e) the maximum unprotected residual capacitance C_i of each field device shall not be greater than 5 nF and the residual inductance L_i not greater than 10 μ H;
- f) field devices shall be suitable for IIC apparatus group and temperature classified in accordance with IEC 60079-15.

The apparatus certificate shall state that the apparatus is suitable for use in a FNICO system. No specification of the residual parameters is required on the certificate or label.

5 Terminator

The line terminators required by the system shall comprise a resistor of value 90 Ω to 102 Ω in series with a capacitor of 0 μ F to 2.2 μ F (including tolerances).

NOTE 1 Operationally a capacitor with a value of 0.8 μ F to 1.2 μ F is required.

The terminator shall be constructed in accordance with IEC 60079-15.

The terminator shall:

- a) have a minimum input parameters of U_i : 17.5 V.;
- b) be isolated from earth in accordance with IEC 60079-15;
- c) have a maximum unprotected residual inductance L_i not greater than 10 μ H;
- d) be suitable for apparatus group IIC and be temperature classified in accordance with IEC 60079-15.

The terminators may be incorporated within field devices or power supplies. The terminator certificate shall state that the terminator is suitable for use in a FNICO system.

NOTE 2 For non-incendive purposes the effective residual capacitance C_i is considered not to affect the safety of the system.

6 Requirements of a FNICO system

A FNICO system is usually of the form illustrated in figure 1.

The cable used in the system shall comply with the following parameters:

- loop resistance R_c - 15 Ω /km to 150 Ω /km;
- loop inductance L_c - 0.4 mH/km to 1 mH/km;
- capacitance C_c - [45 nF/km] 80 nF/km to 200 nF/km;
- maximum length of each spur cable 30 m [60m] in IIC and IIB;
- maximum length of each trunk cable [including the length of all spurs] 1.0 km in IIC and 5 km in IIB;

When cable which complies with this specification is used, no further consideration of cable parameters is necessary.

(Note: The capacitance and line lengths shown in square brackets represent the values that are proposed for FNICO systems. The values outside the brackets are those that exist in the FISCO technical specification.)

The cable parameters may be determined in accordance with annex D of IEC 60079-14.

Where a system comprises

- one source of power,
- any number of field devices up to 32, and
- two terminators, all complying with the requirements of this technical specification, combined with a cable to the above specification,

then that system shall be considered to be adequately safe.

The two terminators shall be situated at the ends of the trunk. The power supply shall be located not more than 40 m from one end of the trunk. Where the power supply is connected via a spur, then that spur is restricted to a length of 40 m.

The safety documentation may be simplified to a list of the equipment, together with relevant certification information used.

The system will be suitable for use in a Zone 2 location.

The temperature classification of each piece of apparatus shall be determined by its certification. It is also necessary to confirm that the permitted maximum ambient temperature of each piece of apparatus is suitable for its intended location.

7 Intrinsically safe apparatus

Intrinsically safe apparatus, including terminators and other ancillaries, certified to the FISCO standard may be used in a FNICO system. Fieldbus devices certified as intrinsically safe but not in accordance with the FISCO standard may be used with a FNICO power supply in a FNICO system provided that they have input parameters of U_i not less than 17.5 V and L_i and C_i not greater than 10 μ H and 5nF respectively.

Where intrinsically safe apparatus is used in a FNICO system, its change of use should be indicated at the point of installation. A plant label marked 'FNICO ExnL system' is an acceptable way of satisfying this requirement.

Note: Since type 'n' apparatus is only considered in normal operation, the input current and power utilised are determined by the apparatus, and the intrinsically safe parameters L_i and P_i are not relevant to non-incendive applications.

8 Simple apparatus

Simple apparatus selected in accordance with IEC 60079-11, and having residual parameters of C_i not greater than 5nF and L_i not greater than 10 μ H may be added to a FNICO circuit without adversely affecting the safety of the circuit.

9 Marking

Each piece of apparatus shall be marked with the word "FNICO" followed by an indication of its function, i.e. power supply, field device or terminator. In addition, each piece of certified apparatus shall be marked in accordance with IEC 60079-15, except where modified by this technical specification.

10 Examples of marking

a) Power supply

FNICO power supply
[Ex nL] IIC
John Jones Ltd
SW99 2AJ UK
Type: DRG OOI
-20 °C < T_a < +50 °C
PTB Nr 01A 2341
Serial No: 014321

b) Field device

FNICO field device
Ex nL IIC T4
Paul McGregor plc
GL99 1JA UK
Type: RWS 001
-20 °C < T_a < +60 °C
INERIS 01 A 1234
Serial No 013241

c) Terminator

FNICO terminator
Ex nL IIC T4
James Bond plc
MK45 6BY UK
Type MI5 007
BAS 01 A 4321
Serial No: 012345

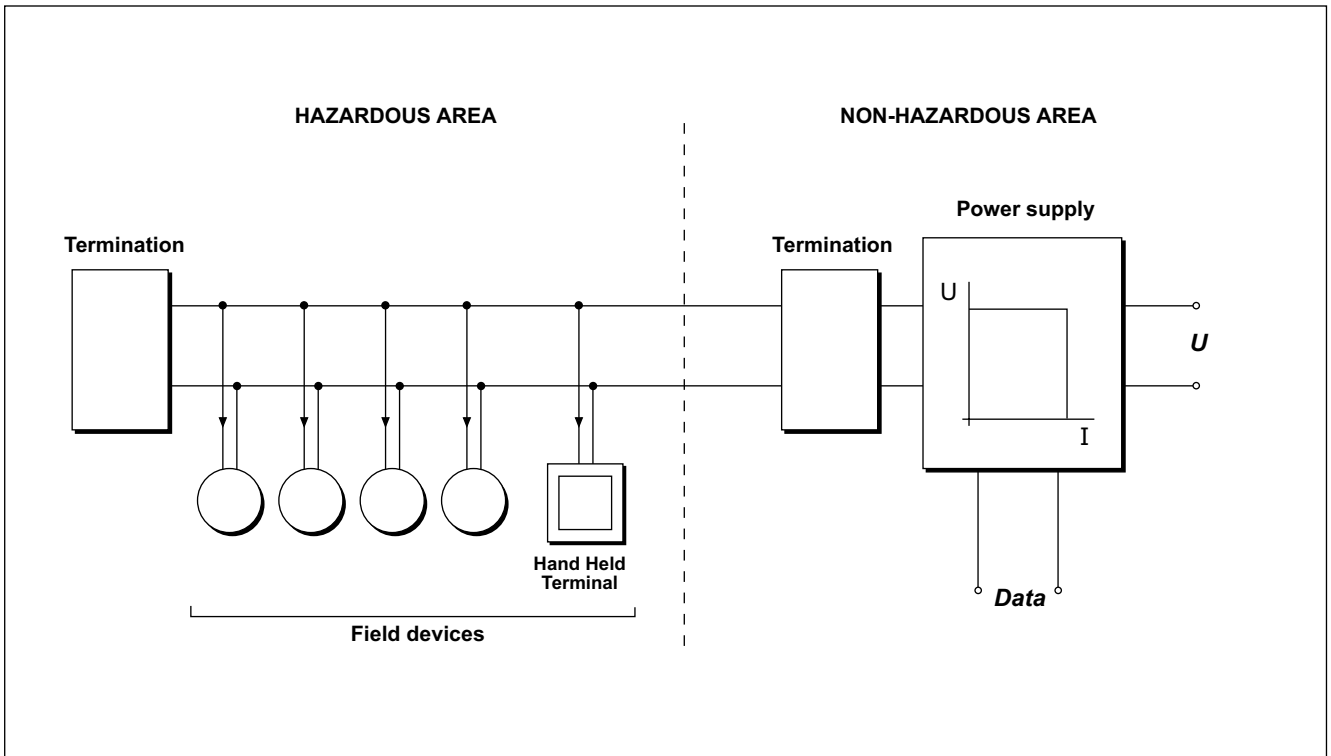

Figure 1 – Typical FNICO system

15 APPENDIX IV : FACTORY MUTUAL INSTALLATION DRAWING

1.0 FNICO rules

The Fieldbus Non-Incendive Concept (FNICO) allows the interconnection of non-incendive or intrinsically safe apparatus in Division 2 or Zone 2 to a source of supply not specifically examined in such combination as a system. The criterion for such interconnection is that the voltage (V_{max}) which the non-incendive or intrinsically safe apparatus can receive must be equal or greater than the output voltage (V_{oc}) provided by the source of supply. In addition, the residual capacitance (C_i) and Inductance (L_i) of each apparatus (other than the terminators) connected to the fieldbus must be less than or equal to 5nF and 10mH respectively.

In each non-incendive fieldbus segment only one active source of supply is allowed to provide the necessary power. The permitted voltage (V_{oc}) of the source of supply must in the range of 14V d.c. to 17.5V d.c. In this instance the 9111-NI and 9112-NI have V_{oc} as given in the table below. All other apparatus connected to the fieldbus cable has to be passive, meaning that it is not allowed to provide energy onto the bus, except for a leakage current of 50mA for each connected device. Separately powered apparatus must have galvanic isolation between its own source of supply and its fieldbus connections.

1.1 Cable

The cable used to interconnect the devices in a FNICO system needs to comply with the following parameters:

- Loop resistance, R_c : 15 Ω /km ...150 Ω /km
- Loop inductance, L_c : 0.4mH/km ...1mH/km
- Capacitance, C_c : 80nF/km ...200nF/km
- Maximum length of each spur cable: 30m in ABCD/IIC and CD/IIB
- Maximum length of each trunk cable: 1km in ABCD/IIC and 5km in CD/IIB

Belden cable type 3076F is an example of a suitable cable.

1.2 Terminators

An approved terminator with the following parameters is suitable at each end of the trunk cable:

$$R = 90 \dots 100\Omega \quad C = 0 \dots 2.2\mu F$$

MTL terminator type FBT1-IS satisfies these requirements.

The 9111-NI and 9112-NI each have a built-in terminator in the non-incendive field circuit.

1.3 System evaluation

If the above rules are respected, the inductance and capacitance of the cable does not need to be considered and will not impair the safety of the installation.

The 9111-NI and 9112-NI power supplies can be used either in FNICO systems or in systems in which safety is established by comparison of non-incendive field wiring parameters.

2.0 Installation notes for FNICO only:

The FNICO concept allows the interconnection of FM approved non-incendive devices with FNICO parameters or FM approved intrinsically safe devices with FISCO parameters, not specifically examined in combination as a system when the following conditions is met:

- $V_{oc} \leq V_{max}$, where the normal operating current is controlled by the non-incendive field wiring apparatus.

3.0 Installation notes for circuits evaluated using non-incendive field wiring parameters:

FM approved devices with non-incendive field wiring parameters not specifically examined in combination as a system may be interconnected when any of the conditions specified in Clause 7.7 of ANSI/ISA-12.12.01-2000 is met.

9111-NI				
Groups	Ca (F)	La(mH)	Voc (V)	Isc (mA)
AB/IIC	0.12	697.5	14.0	233
CE/IIB	2.4	2370		
DFG/IIA	9.2	3820		

9112-NI				
Groups	Ca(mF)	La(mH)	Voc (V)	Isc (mA)
CE/IIB	0.205	707	14.8	380
DFG/IIA	2.95	1640		

4.0 Installation notes common to FNICO and non-incendive field wiring concepts:

- 4.1 Dust-tight conduit seals must be used when installed in Class II and Class III environments.
- 4.2 Control equipment connected to the unclassified location side of the FNICO power supplies must not use or generate more than 250 Vrms or Vdc.
- 4.3 Installation should be in accordance with ANSI/ISA-12.12.01-2000, "Nonincendive electrical equipment for use in Class I and II, Division 2 and Class III, Divisions 1 and 2 Hazardous (Classified) Locations" and the National Electrical Code (ANSI/NFPA 70) Sections 501 and 502.
- 4.4 All field apparatus must be FM approved.
- 4.5 The field apparatus manufacturer's installation drawing must be followed when installing this equipment.
- 4.6 Optional connector. The connector must either be appropriately approved by FM or be Simple Apparatus in accordance with ANSI/NFPA 70 Section 504.2 and as referred to in Section 501.4. If certified, the connector may contain status indication and/or current limitation.
- 4.7 Opening, shorting and grounding of the field wiring is permitted while under power.
- 4.8 Both the 9111-NI and the 9112-NI FNICO Power Supply have a Non-Linear output.
- 4.9 This drawing forms part of the FM Certification Documentation and must not be modified without reference to the certifying authority.

Contd/...

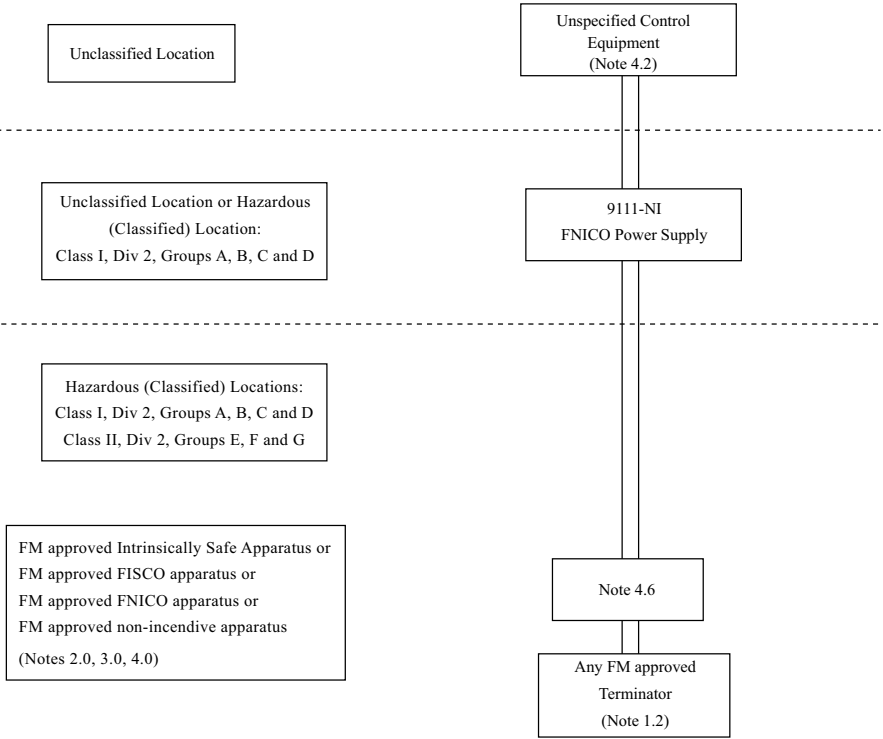

9111-NI: Zone Classification; Gas Groups A-D

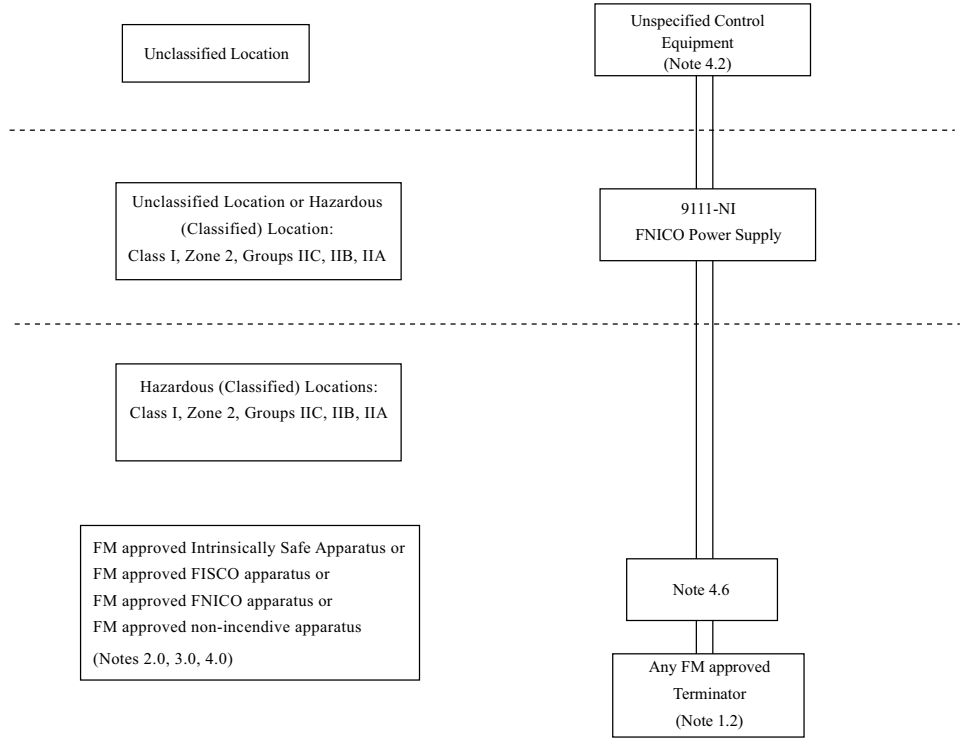

9111-NI: Division Classification; Gas Groups IIC, IIB and IIA

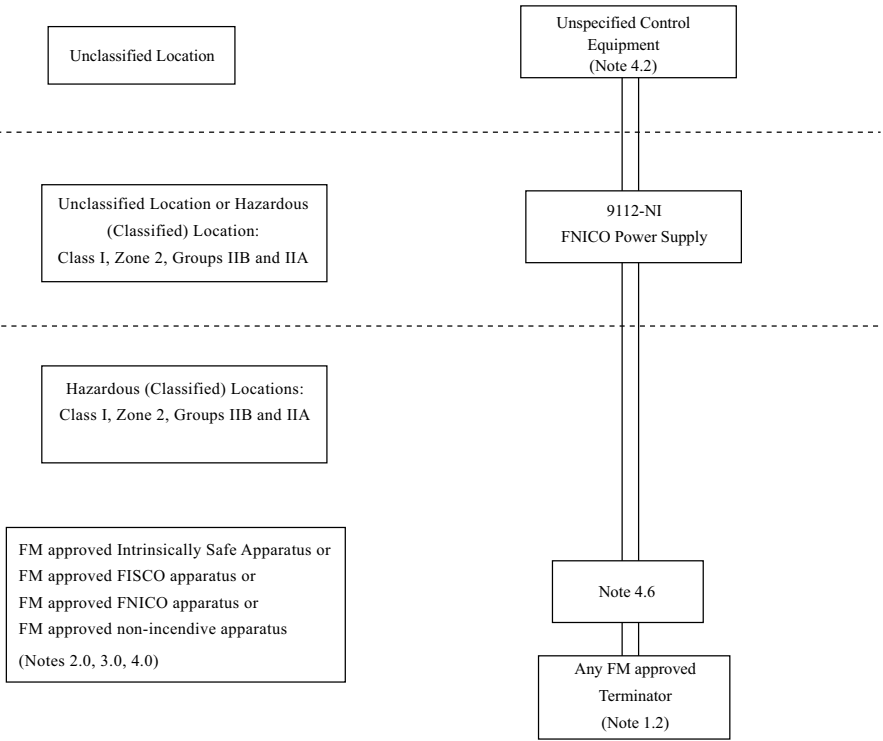

9112-NI: Division Classification; Gas Groups IIB and IIA

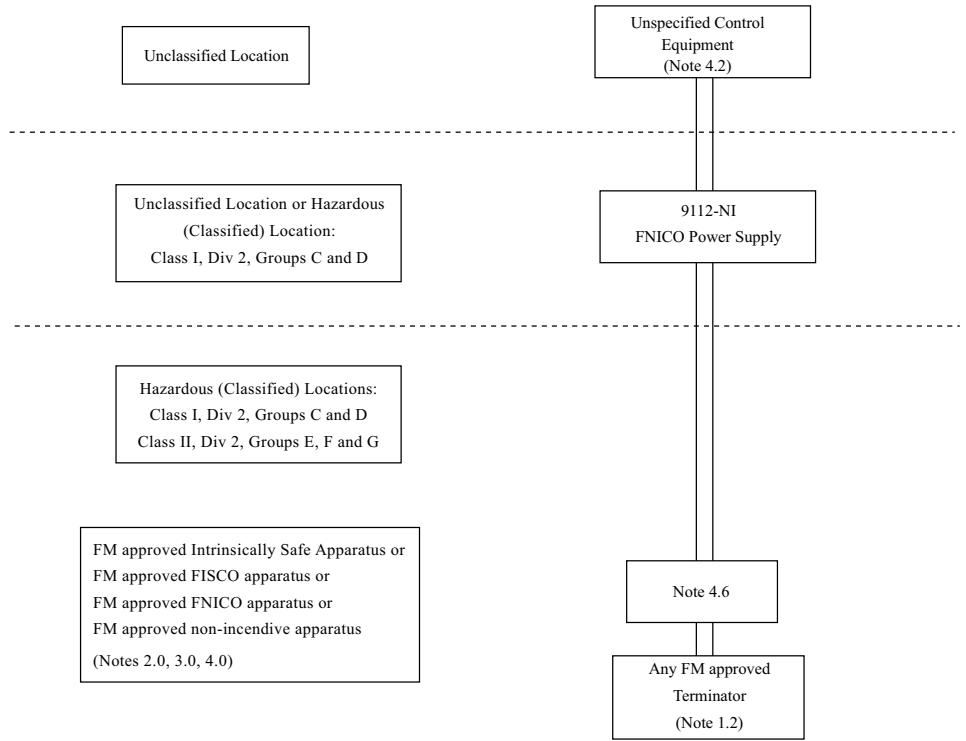

9112-NI: Zone Classification; Gas Groups C, D

MTL Instruments Pty Limited

9 Vinnicombe Drive
PO Box 1441, Canning Vale,
Perth, WA 6155
Australia
Tel: +61 (0)8 9455 2994 Fax: +61 (0)8 9455 2805
E-mail: enquiries@mtlaus.com.au

MTL Instruments BVBA

Fruithoflaan 122 Bus 4
B-2600 Antwerpen
Belgium
Tel: +32 (0)3 236 53 47 Fax: +32 (0)3 236 09 30
E-mail: info@mtlbelux.com

MTL Canada Safety Instrumentation

20 Regan Road, Unit 17
Brampton, Ontario L7A 1C3
Canada
Tel: +1 905 840 7850 Fax: +1 905 840 7852
E-mail: cinfo@mtlnh.com

MTL Instruments (Beijing) Ltd

Room 07-05A, The Gateway
No 10 Yabao Road, Chaoyang District
Beijing 100020
Tel: +86 10 6591 5718, 5720, 5721 Fax: +86 10 6591 5725
E-mail: bjsales@mtlsing.com.sg

MTL Instruments sarl

Bâtiment SILIC 4, 1 rue des Vergers
69760 Limonest
France
Tel: +33 (0)4 78 64 98 32 Fax: +33 (0)4 78 35 79 41
E-mail: info@mtl-inst.fr

MTL Instruments GmbH

An der Gumpgesbrücke 17
D-41564 Kaarst
Germany
Tel: +49 (0)2131 718930 Fax: +49 (0)2131 7189333
E-mail: info@mtl.de

MTL India Private Limited

No.36, Nehru Street
Off Old Mahabalipuram Road
Sholinganallur,
Chennai - 600119
Tel: + 91 (0) 44 4501660 Telefax: + 91 (0) 44 4501463
E-mail: sales@mtlindia.com

MTL Italia srl

Via Fosse Ardeatine, 4
I - 20092 Cinisello Balsamo MI
Italy
Tel: +39 (0)2 61802011
Fax: +39 (0)2 61294560
E-mail: info@mtl-inst.it

MTL Instruments KK

3rd Floor, Gotanda Masujima Building
1-8-13 Higashi-Gotanda, Shinagawa-Ku
Tokyo 141-0022
Japan
Tel: +81 (0)3 5420 1281
Fax: +81 (0)3 5420 2405
E-mail: sales@mtlkk.co.jp

MTL Instruments BV

MTL Systems BV
de Houtakker 33, 6681 CW Bommel
The Netherlands
Tel: +31 (0)48 1450250 Fax: +31 (0)48 1450260
E-mail: info@mtlbelux.com

MTL Instruments Pte Limited

150 Kampong Ampat
#06-01 KA Centre
Singapore 368324
Tel: +65 487 7887 Fax: +65 487 7997
E-mail: sales@mtlsing.com.sg

MTL Instruments

PO Box 7392, Abu Dhabi
UAE
Tel: +971 2 63 22399 Fax: +971 2 63 22566
E-mail: mtlgulf@mtl-inst.com

MTL Instruments

Power Court, Luton, Bedfordshire
England LU1 3JJ
Tel: +44 (0)1582 723633 Fax: ++44 (0)1582 422283
E-mail: enquiry@mtl-inst.com

MTL Incorporated

9 Merrill Industrial Drive, Hampton NH 03842
USA
Tel: +1 800 835 7075, +1 603 926 0090
Fax: +1 603 926 1899
E-mail: info@mtlnh.com

